



Ref. T4/4.01

MSC.1/Circ.1205
26 May 2006

**GUIDELINES FOR DEVELOPING OPERATION AND MAINTENANCE
MANUALS FOR LIFEBOAT SYSTEMS**

1 The Maritime Safety Committee, at its eighty-first session (10 to 19 May 2006), taking into account the number of casualties with lifeboat systems, further recognizing the need to improve manuals for operation and maintenance of lifeboat systems, and having considered proposals by the Sub-Committee on Fire Protection at its fiftieth session, approved the Guidelines for developing operation and maintenance manuals for lifeboat systems, as set out in the annex.

2 Member Governments are invited to bring the annexed Guidelines to the attention of all parties concerned with their application, as appropriate.

ANNEX

GUIDELINES FOR DEVELOPING OPERATION AND MAINTENANCE MANUALS FOR LIFEBOAT SYSTEMS

1 Scope and purpose of the guidelines

Seafarers often change ships and sometimes are not familiar with the lifeboats on their ships. Casualties with lifeboat systems are often caused by poor understanding of the lifeboat systems, especially release gear systems. User-friendliness of manuals for lifeboat systems is, therefore, important to help prevent casualties.

The purpose of these guidelines is to encourage development of user-friendly manuals for operation and maintenance of lifeboat systems including launching appliances. These manuals should be easy to understand. The guidelines demonstrate the appropriate level of detail and use of illustrations in explaining the safe use of critical systems. Manufacturers of lifeboats and launching/recovery appliances are invited to make manuals easy to understand, taking into account these guidelines. The use of video materials in conjunction with printed manuals can be an effective tool for mariners who may not be inclined to read a manual.

These guidelines are not applicable to the emergency instructions required by SOLAS regulation III/8, operating instructions such as posters and signs required by SOLAS regulation III/9 or other brief instructions for operation of lifeboats.

These guidelines are for manuals to be carried on ships for use by seafarers, and accordingly the section on weekly and monthly inspection and maintenance does not refer to detailed maintenance/repair work. Detailed maintenance/repair work should be conducted by the manufacturer's representative or a person appropriately trained and certified by the manufacturer for the work in accordance with MSC.1/Circ.1206.

2 Collaboration of manufacturers of the lifeboat and the launching appliance

A manual for a lifeboat system including launching appliance should be developed with the collaboration of manufacturers of the lifeboat and the launching appliance and preferably be a single document. As a minimum, the use of different words for the same gear/parts of the lifeboat system should be eliminated by the collaboration of manufacturers of the lifeboat and the launching appliance to prevent misunderstanding by seafarers. Hereafter, these guidelines assume a manual for a lifeboat system includes the launching appliance as a minimum, but separate lifeboat, release gear, and launching appliance manuals may be effective if adequately co-ordinated and using the same style of presentation per these guidelines.

3 Contents of a manual for a lifeboat system

3.1 Items to be included

An operation and maintenance manual for a lifeboat system should include, as a minimum, the following items:

- .1 overview and specification of the lifeboat system;
- .2 explanation of the structure and working principle of the major parts of the lifeboat system including release gear systems;

- .3 operation of the lifeboat system; and
- .4 routine inspection and maintenance of the lifeboat system.

3.2 *Organization, description and layout of manual*

3.2.1 *Outline*

It is recommended that a manual for a lifeboat system be developed with the following major divisions:

- 1 General description of the whole lifeboat system.
- 2 Method of checking proper closure of release hooks.
- 3 Launching operation.
- 4 Recovery operation.
- 5 On-load/off-load release gear.
- 6 Inspection and maintenance.

3.2.2 *Explanation of major components and their function*

The structure and working principle of the lifeboat's major components, in particular the on-load/off-load release gear, should be explained using figures and preferably three-dimensional perspectives. In addition, the operation of the release gear should be described sequentially, using short phrases written in the active voice.

3.2.3 *Operation of lifeboat system including release gear systems*

The operation of the lifeboat system should be described using the following elements:

- .1 flow of the operation should be explained;
- .2 detail of operation should be explained with figures. Operation and relevant movement of the parts of the release gear should be described with illustrations/photos, preferably using annotations and arrows to show direction of movement; and
- .3 hazards, precautions and notes should be identified with symbols specific to the level of risk. As an example of the various levels of risk and the appropriate associated symbols, the following are recommended:
 - .1 For the highest level of risk, such as in the explanation of "on-load release operation", the following symbol (red background) should be used with a warning statement similar to the following:



This operation releases the lifeboat and may result in the lifeboat dropping and causing death or serious injury if released too soon.

Warning

Note: International standard symbols (ISO 3864-1 and ISO 7010) are recommended where appropriate, but since marine use is excluded from the scope of these standards, and they fail to indicate different levels of risk, the “graduated” symbols are recommended.

- .2 For the second highest level of risk, such as in the explanation of “davit arm stop release operation”, the following symbol (yellow background) should be used with a caution statement similar to the following:



Incorrect or incomplete resetting may cause the lifeboat to drop resulting in death or serious injury.

Caution

- .3 For less critical mandatory instructions the following symbol (blue background) should be used with appropriate instruction:



Place the manual gripe out of the way to prevent tangling round the lifeboat.

...

Mandatory

- .4 Important notes may be emphasized with symbol and style of instructions similar to the following:



In case the hook is not released by the above operations, confirm condition of each hook and whether the boat is waterborne or not. Even though the hooks cannot be released by the above mentioned off-load release operation, the on-load release procedure, described in the following pages, is possible.

Note

- .5 Prohibited actions should use the following symbol (coloured red) and style of instruction:



Never enter lifeboat without ensuring complete closure of release hooks. Incomplete resetting of the release hooks can cause the lifeboat to drop and may result in the death of occupants.

Never

3.2.4 *Inspection and maintenance*

The items for weekly and monthly inspection/maintenance and other inspection/maintenance should each be explained separately.

4 **Improvement of user-friendliness of a manual**

4.1 *Use of figures/photographs*

Figures, preferably coloured, or photographs should be used as far as practicable to make manuals easy to understand.

4.2 *Use of standard wording*

The following standard wording should be used to explain lifeboat systems where provided, and for each of the applicable items illustrations should be provided to show the items and their location in the lifeboat or on the ship. The use of alternative terms for variety should be avoided, except to further define or clarify a term so that the reader never has to guess what item or system is being discussed.

- .1 Davit/winch:
 - .1 Auto releasing gripe
 - .2 Davit arm
 - .3 Davit arm stop
 - .4 Davit remote control wire handle
 - .5 Frame
 - .6 Maintenance (hanging off) pennant attachment points, if provided
 - .7 Manual gripe, if provided
 - .8 Remote control wire
 - .9 Winch manual brake safety pin
 - .10 Winch hand crank handle
 - .11 Winch centrifugal or lowering brake
 - .12 Winch hand brake or stop brake lever
- .2 Freefall:
 - .1 Roller or sliding pad
 - .2 Sea lashing rope
 - .3 Emergency release device
- .3 Release gear:
 - .1 Hook control cable
 - .2 Hook retainer (lock piece)
 - .3 Hydrostatic interlock
 - .4 Hydrostatic interlock lever, if provided
 - .5 Interlock (“mechanical protection” of on-load release)
 - .6 Maintenance (hanging off) pennant attachment points, if provided
 - .7 On-load release
 - .8 Release handle

- .9 Release handle “closed (locked)” and “open” positions
 - .10 Release handle “safety pin”
 - .11 Release hook (hook unit) (fore and aft hooks)
 - .12 Reset lever, if provided
 - .13 Safety latch (keeper)
- .4 Suspension:
- .1 Foul weather recovery strops
 - .2 Suspension block
 - .3 Suspension link (lifting ring)
- .5 “Officer in charge” of lifeboat

5 Example of an operation and maintenance manual for a lifeboat system

An example of an operation and maintenance manual for a fire-protected lifeboat system is attached in the following pages just for reference. It demonstrates the suitable level of detail that should be expected for manuals. It should be noted that lifeboat systems are different from each other and some specifications in the example manual are not applicable to lifeboat systems of other types. The example attached at appendix is a model manual which is recommended as an example for developing specific manuals for lifeboat systems launched by falls, but the same general principles should be used for manuals for freefall lifeboat systems.

* * *

APPENDIX

EXAMPLE OPERATION AND MAINTENANCE MANUAL FOR A LIFEBOAT SYSTEM*

Table of contents

- 1 General
- 2 Method of checking proper closure of release hooks
- 3 Launching operation
 - 3.1 Preparation before launching
 - 3.2 Setting painter
 - 3.3 Release of safety pin for winch hand brake lever
 - 3.4 Release of davit arm stop
 - 3.5 Boarding the lifeboat
 - 3.6 Launching procedure
 - 3.7 Release gear operation
 - 3.8 Painter release and lifeboat operation
- 4 Recovery operation
 - 4.1 Resetting procedure of release hook
 - 4.2 Recovery procedure
 - 4.3 Stowage procedure
- 5 On-load/off-load release gear system
 - 5.1 General
 - 5.2 Fore and aft hook units
 - 5.3 Release handle unit
 - 5.4 Hydrostatic interlock unit
- 6 Inspection and maintenance
 - 6.1 General precautions
 - 6.2 Inspection and maintenance of lifeboat and release gear system
 - 6.3 Inspection and maintenance of launching appliances (davits and winches)

* Of a lifeboat being launched using falls and a winch, hereinafter referred to as a lifeboat.

1 General

The lifeboats are stored on the boat davits on both sides of the ship. In case of emergency, the crew can board the lifeboat and escaped with the lifeboat directly from its stowage position.

The launching appliance consists of a boat davit (davit arm, frame, platform, falls, suspension block, and gripes/lashing device) and a boat winch (reduction gears, hand brake and centrifugal brake).

Swinging out and lowering of the lifeboat can be controlled both from the inside of the lifeboat and at the ship's deck. The lowering speed of the lifeboat can be controlled by operating the remote control wire inside the lifeboat or by operating the remote control lever on the ship's deck. Moreover, it is possible to suspend the lowering operation of the lifeboat at any height.

Recovery of the lifeboat is performed by operating the boat winch with the push-button switch box. When the davit arm reaches a prescribed position, the boat winch is automatically stopped by the limit switch. After the activation of the limit switch, the boat winch is operated manually to wind up the lifeboat to its stowage position. The boat winch is provided with a safety device to prevent the reverse operation of the manual handle.

The lifeboat is equipped with on-load/off-load release gear which complies with the requirements of the IMO Life-Saving Appliance (LSA) Code. The release gear system is equipped with a hydrostatic interlock system so that it will normally not release the hooks until the boat is waterborne.

To avoid possible injury or death, read this manual carefully before using the boat davit, the boat winch, and the on-load/off-load release gear.

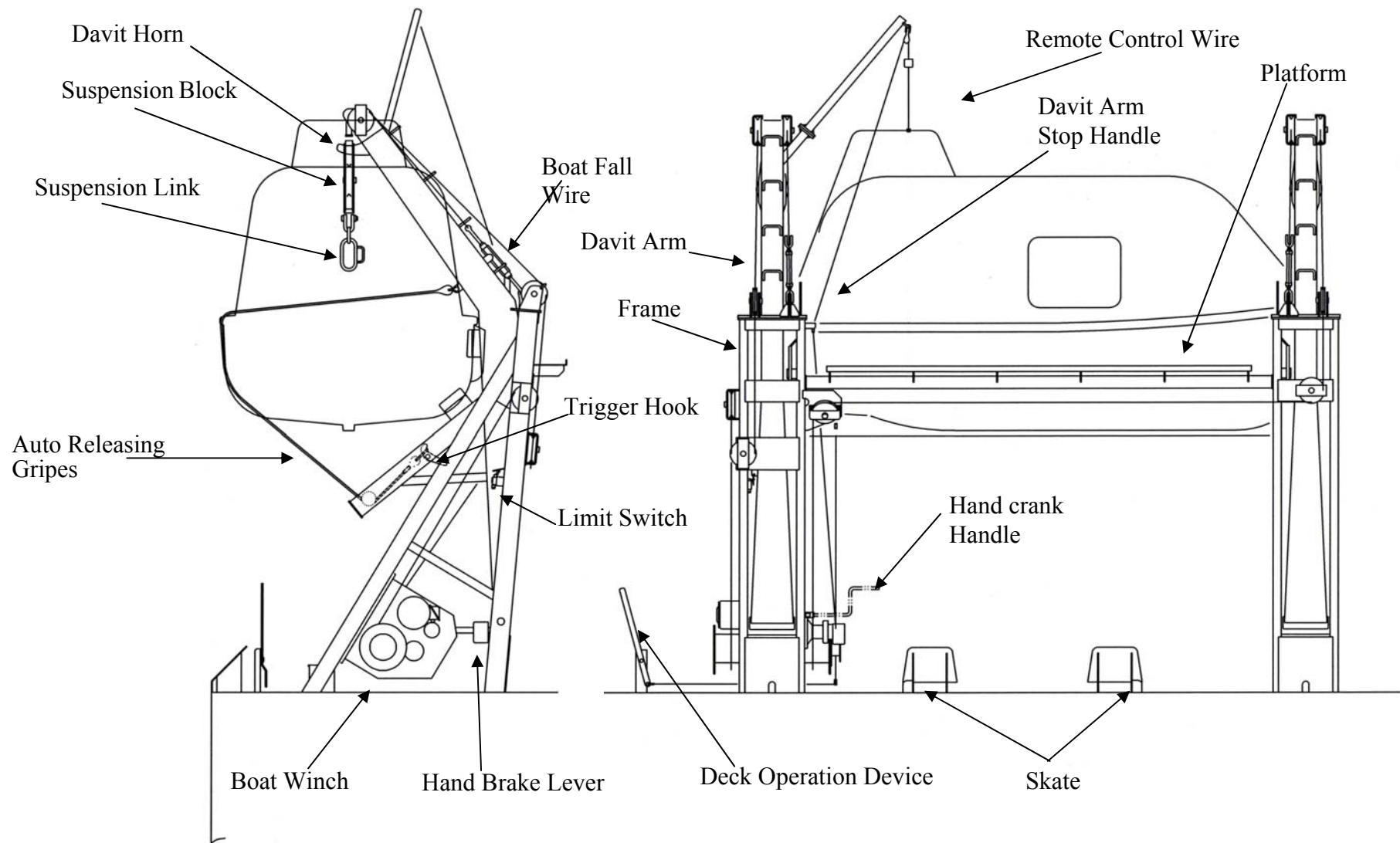

Fig. 1.1 Lifeboat davit arrangement

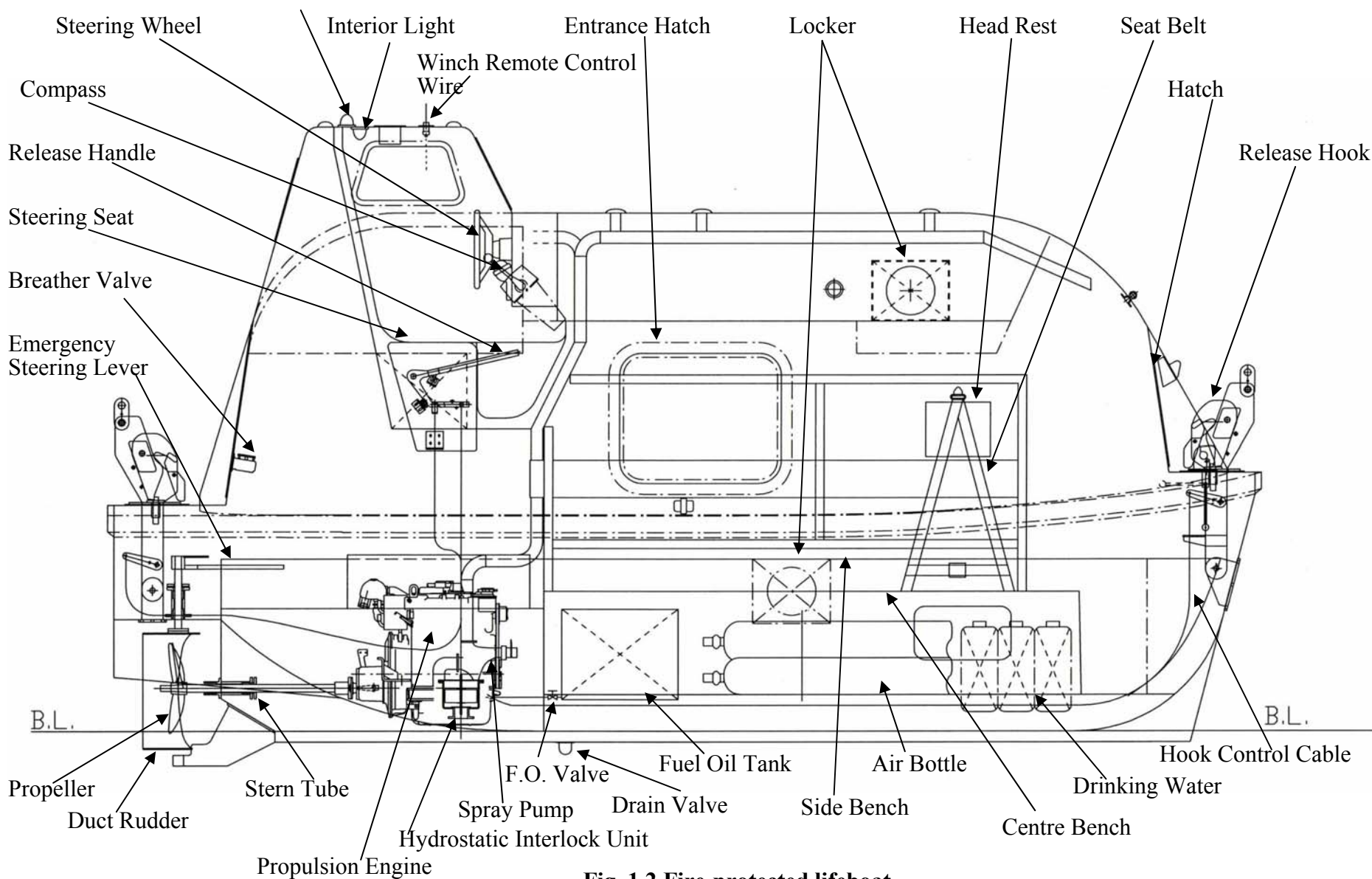
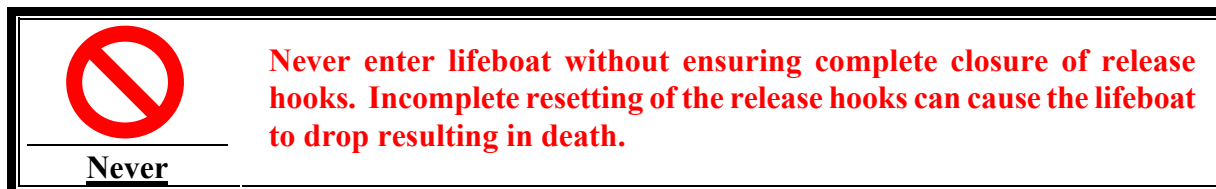

Fig. 1.2 Fire-protected lifeboat

2 Method of checking proper closure of release hooks

2.1 Safe use and operation of lifeboats during drills and inspection and maintenance is dependent on knowing that the release gear is properly reset.





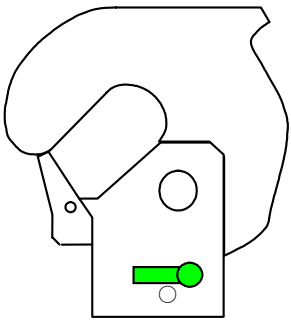
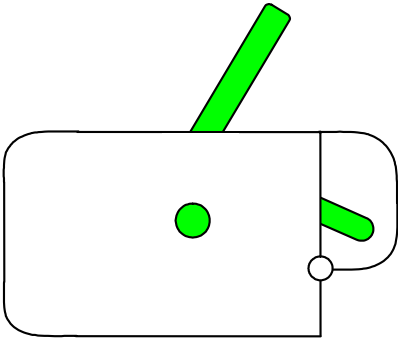

2.2 Purpose of on-load release. The IMO LSA Code requires, among other things, that the lifeboat be fitted with “*on-load release capability which will release the lifeboat with a load on the hooks. The release mechanism shall be so designed that crew members in the lifeboat can clearly observe when the release mechanism is properly and completely reset and ready for lifting. . . .*” On-load release is needed for launching when there is a current, when the ship is making way, or potentially if there are waves which cause the hydrostatic interlock to only release intermittently. On-load release also allows an empty or fully loaded boat to drop from any height, which can kill or seriously injure the occupants. Therefore it is critical to know that the release gear is properly reset and the release handle secured.

2.3 Ensuring release hook closure. The first thing to check whenever entering the lifeboat when it is (or will be) supported by the falls is properly reset as follows:

No.	Operation Guide	Schematic Diagram
1	<p>Check that the reset lever on each hook is horizontal and in contact with its stop.</p> <p><Activity in the lifeboat></p>	
2	<p>Check that the release handle is in the closed (locked) position and safety pin is installed.</p> <p><Activity in the lifeboat></p>	

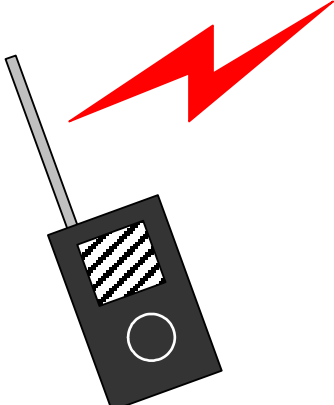
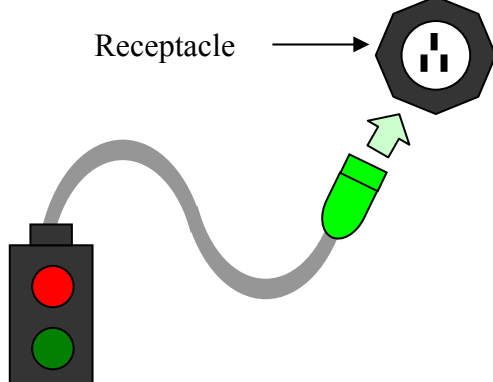
3 Launching operation

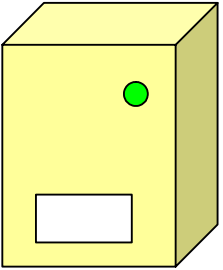
3.1 Preparation before launching

No.	Operation Guide	Schematic Diagram		
1	<p>Prepare transceivers, and confirm the communication condition.</p> <p><Activity on the ship></p>			
2	<p><In case of drill></p> <p>Connect the push-button switch for recovering to the receptacle.</p> <p><Activity on the ship></p>			
3	<p><In case of drill></p> <p>Turn on the power switch of start panel.</p> <table border="1" data-bbox="284 1612 746 1691"> <tr> <td data-bbox="284 1612 406 1691">  </td> <td data-bbox="406 1612 746 1691"> <p><u>Detach the cable for the storage battery charge.</u></p> </td> </tr> </table> <p><Activity on the ship></p>		<p><u>Detach the cable for the storage battery charge.</u></p>	
	<p><u>Detach the cable for the storage battery charge.</u></p>			
4	<p>Don life jackets.</p> <p><Activity on the ship></p>			

3.2 *Setting of painter*

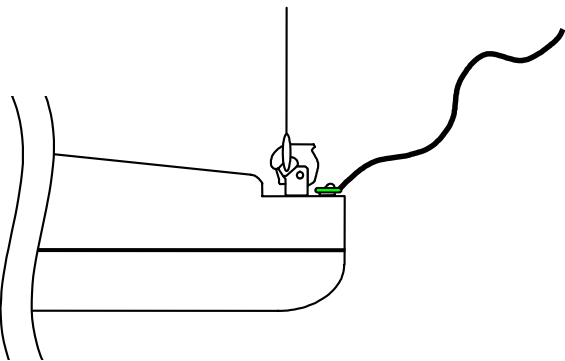
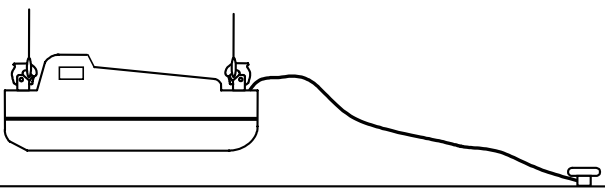
No.	Operation Guide	Schematic Diagram
1	<p>Confirm the connection of the painter on the painter release device of the lifeboat.</p> <p><Activity on the lifeboat></p>	
2	<p>Confirm the connection of the painter as far forward as practicable inboard of the falls but outboard of everything else.</p> <p><Activity on the ship></p>	

	<p>Ensure the painter is lead as far forward as practicable inboard of the lifeboat falls but outboard of everything else. Failure to do so will result in severe difficulties clearing the vessel during abandonment.</p> <p><u>Caution</u></p>
---	--

3.3 Release of safety pin (if fitted) for winch hand brake lever

	<p>The safety pin of the winch hand brake should not be pulled out until the completion of the preparation described in paragraphs 3.1 and 3.2.</p> <p>Caution</p>
---	---

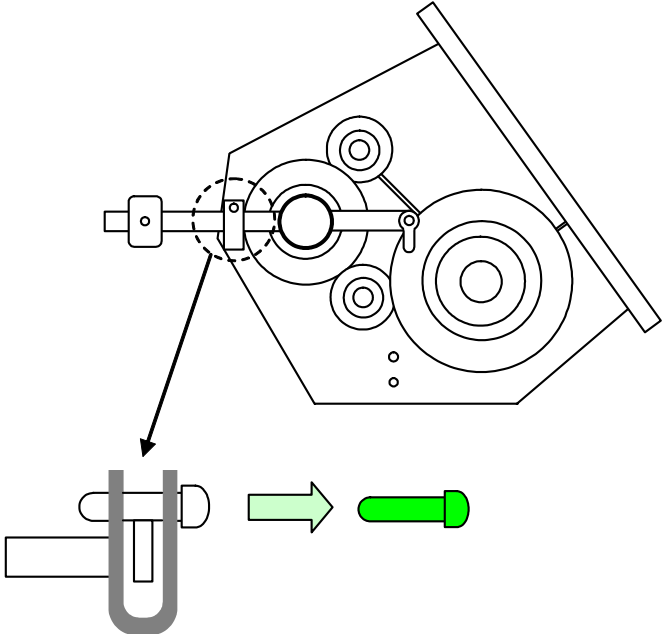
No.	Operation Guide	Schematic Diagram
1	<p>Pull out the safety pin (if fitted).</p> <p><Activity on the ship></p>	

3.4 Release of davit arm stopper

Go up to the platform of the davit system (platform for boarding the lifeboat).

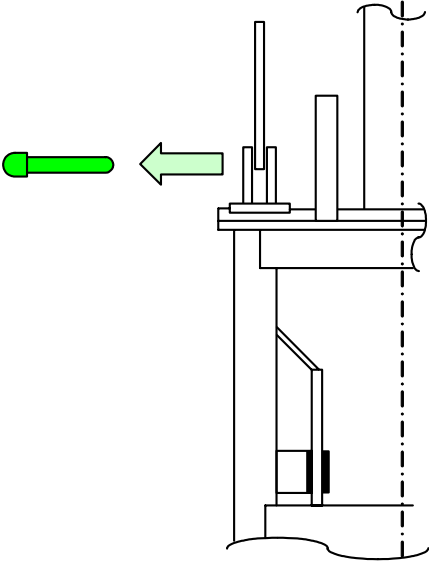
No.	Operation Guide	Schematic Diagram
1	<p>Wind the boat fall manually to take off the slack. Pull out the safety pin of the davit arm stop, if fitted.</p> <p><Activity on the ship></p> <p>Note: Safety pins are generally intended only for use during maintenance or in port.</p>	

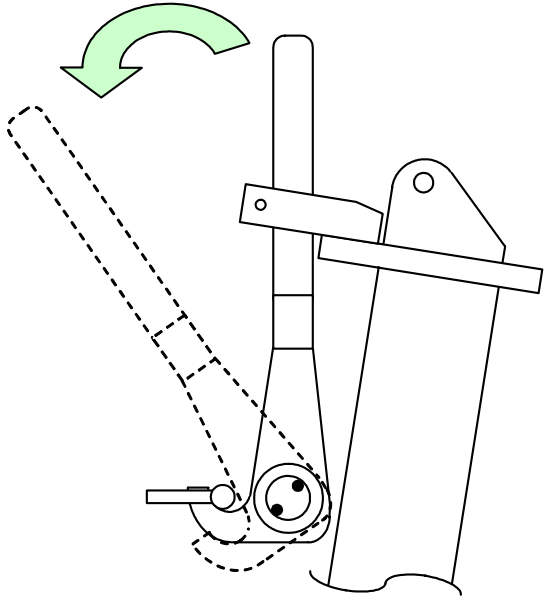
No.	Operation Guide	Schematic Diagram
2	Release the davit arm stop by operating the handle. <Activity on the ship>	

 <p>Caution</p>	<p>The handle should be fully operated to prevent the davit arm stop from being caught with the lock device.</p>
--	--

3.5 Boarding the lifeboat

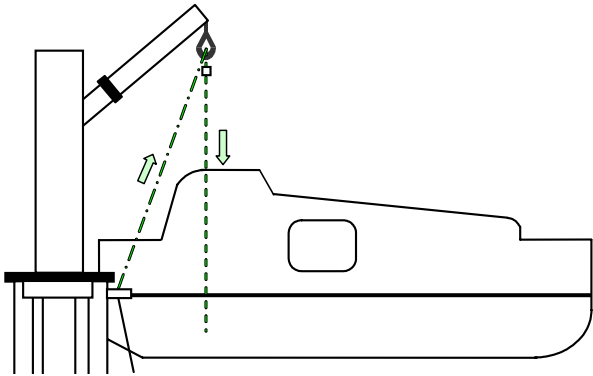
No.	Operation Guide	Schematic Diagram
1	Confirm that the remote control wire is drawn into the lifeboat. <Activity on the ship>	

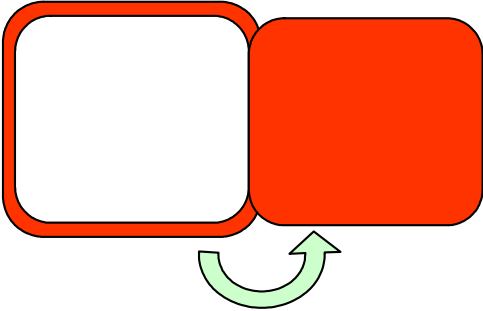
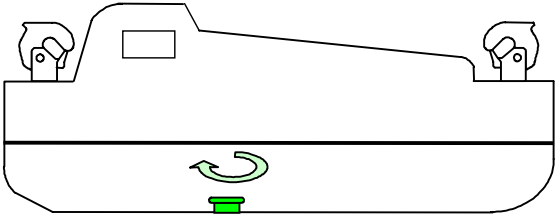
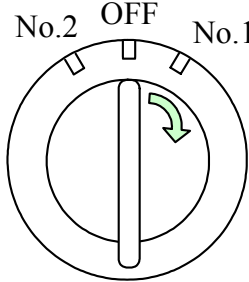
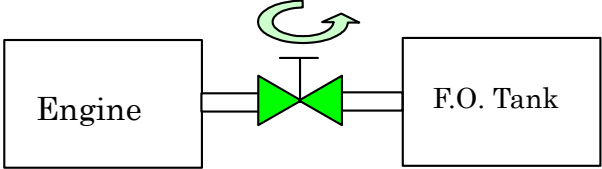
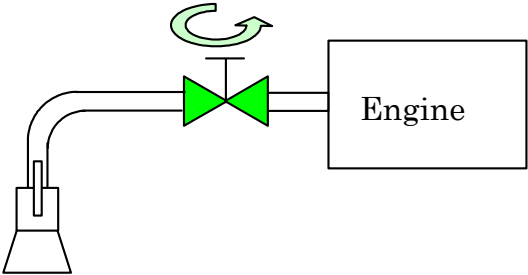
No.	Operation Guide	Schematic Diagram
2	<p>Open the lifeboat boarding door and board the lifeboat.</p> <p><Activity on the ship> and <Activity in the lifeboat></p>	
3	<p>Ensure the bottom plug is fitted and tight.</p> <p><Activity in the lifeboat></p>	
4	<p>Turn on the power supply switch.</p> <p><Activity in the lifeboat></p>	
5	<p>Open the fuel oil valve.</p> <p><Activity in the lifeboat></p>	
6	<p>Confirm that the cooling seawater valve is open.</p> <p><Activity in the lifeboat></p>	

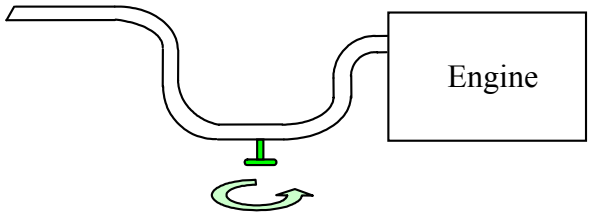
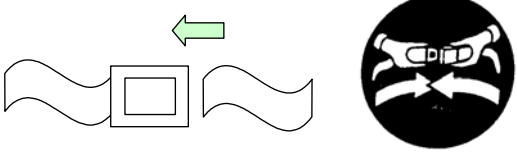
No.	Operation Guide	Schematic Diagram
7	Close the drain valve on exhaust pipe. <Activity in the lifeboat>	
8	Fasten seatbelt. <Activity in the lifeboat>	



Seating positions of persons should be carefully selected to maintain a good trim of the lifeboat.

Caution



If the seat belt is not fastened, serious injury or death may occur.

Warning

3.6 Launching procedure

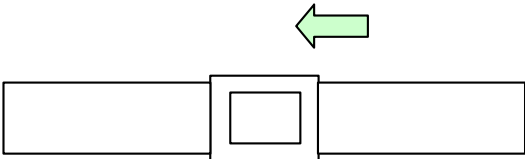
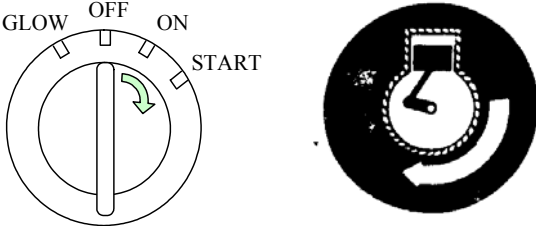
No.	Operation Guide	Schematic Diagram
1	Confirm that all crew boarded in the lifeboat are seated and their seatbelts are fastened. <Activity in the lifeboat>	
2	Start engine. <Activity in the lifeboat>	

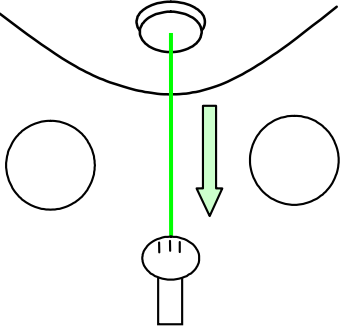
No.	Operation Guide	Schematic Diagram
3	<p>Pull down the winch remote control wire.</p> <p><Activity in the lifeboat></p>	



Caution

- Ensure that no gripe or lashing is tangled around the fore and aft hooks.
- Pull down the remote control wire gently and slowly during swinging out of the lifeboat.
- Only pull down the remote control wire fully to lower the boat after swing out is complete.
- The helmsman must tell the crew to standby for splashdown when the lifeboat reaches the vicinity of the water surface.



Warning

- When using remote control gear from within the boat never wind the cord or wire around fingers, hand or wrist as this may result in the cutting off of fingers/hand.
- Do not stop the swinging out operation at deck position. Stopping shakes the lifeboat and may cause casualties.
- A rapid swing out may cause dangerous impact on the boat when the davit arm reaches the deck position.
- Inching operation shakes the lifeboat and is dangerous.



Note

During lifeboat drills, the above mentioned procedures may not be applicable because the lowering operation may be controlled from the ship's deck using the deck operation device.

3.7 Release gear operation

3.7.1 Releasing procedure

A flow chart of the off-load and on-load releasing procedures is shown in the following figure.

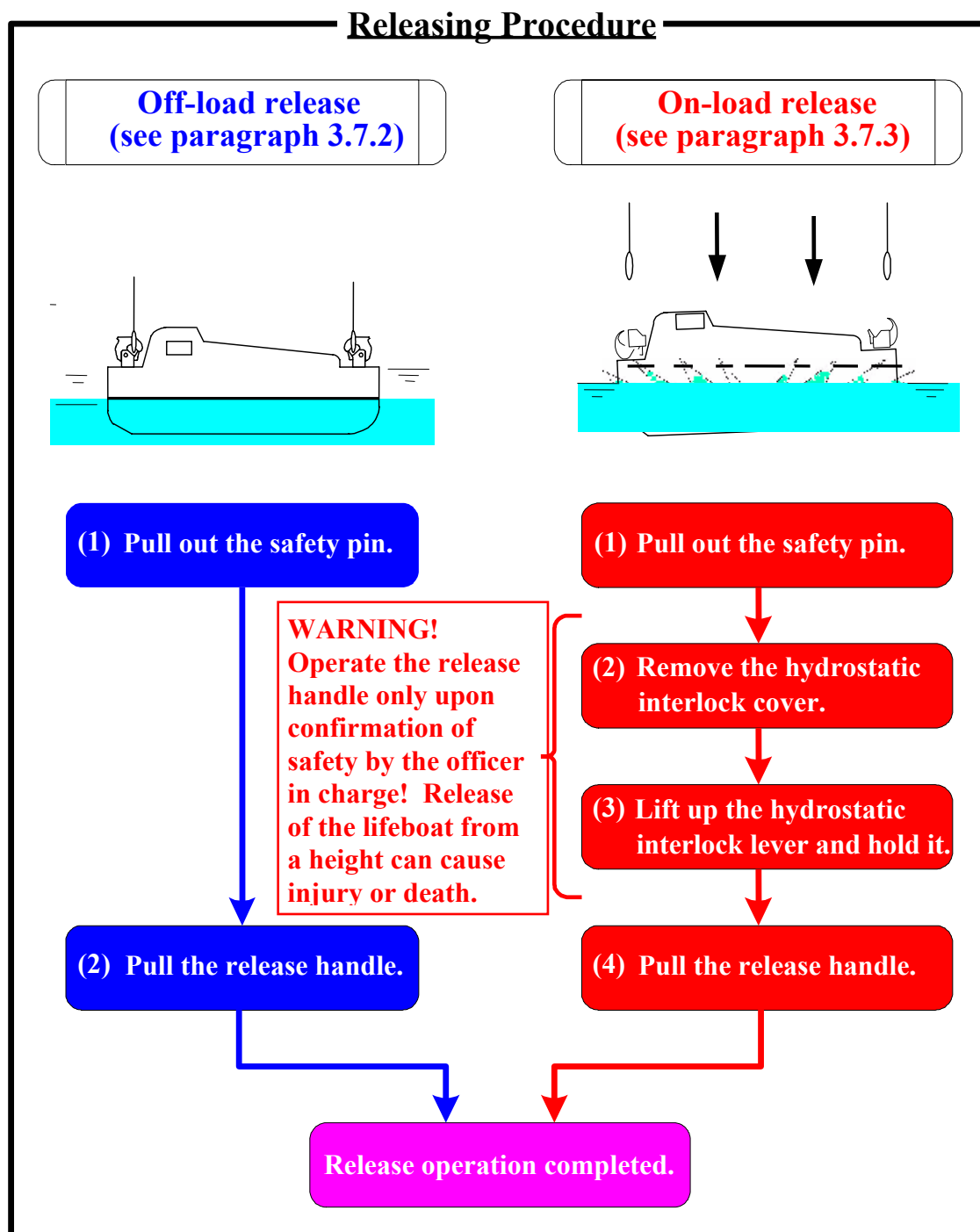

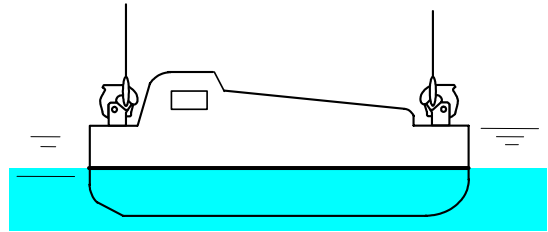

3.7.2 Off-load release

This operation is the normal method of launch and release and is conducted when the lifeboat is fully waterborne.

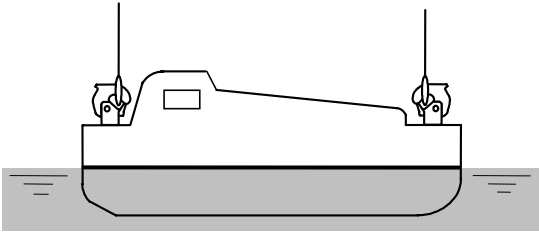
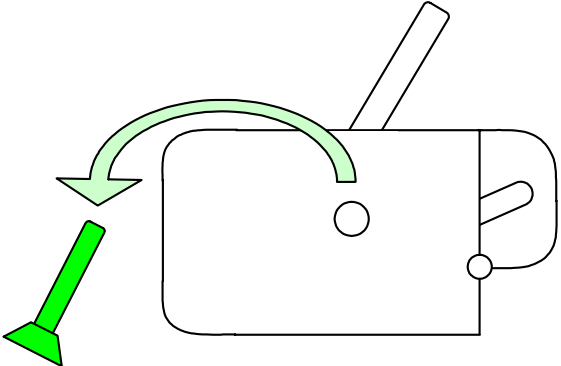
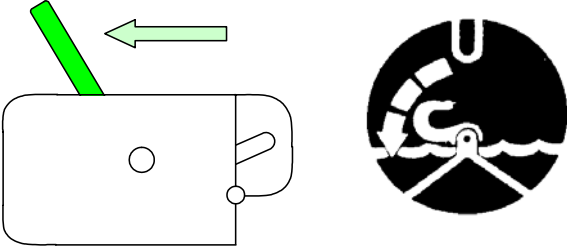

 Caution	<p>Confirm the following before the operation:</p> <ul style="list-style-type: none"> • The lifeboat is fully waterborne. • The engine is started. • All crew are in their seats with their seatbelts fastened.
---	---

No.	Operation Guide	Schematic Diagram
1	<p>Confirm that the lifeboat is waterborne.</p> <p><Activity in the lifeboat></p>	
2	<p>Pull out the release handle safety pin.</p> <p><Activity in the lifeboat></p>	
3	<p>Pull the release handle to the fully open position by one action.</p> <p><Activity in the lifeboat></p>	

 Note	<p><u>In a case where the hook is not released by the above operations, confirm condition of each hook and whether the boat is waterborne or not. Even though the hooks cannot be released by the off-load release operation described above, on-load release procedure, described in the following pages, is possible.</u></p>
--	--

3.7.3 On-load release



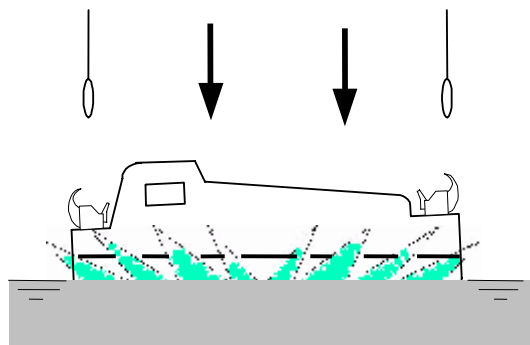

This operation is conducted when the lifeboat is not fully waterborne.

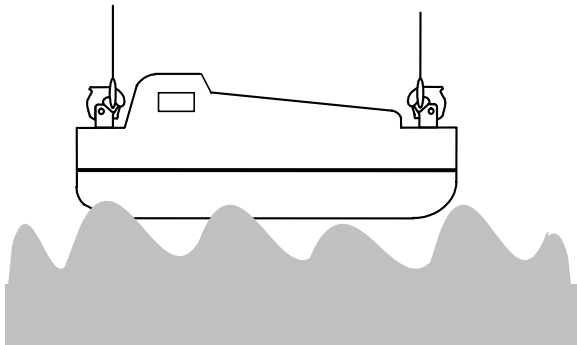
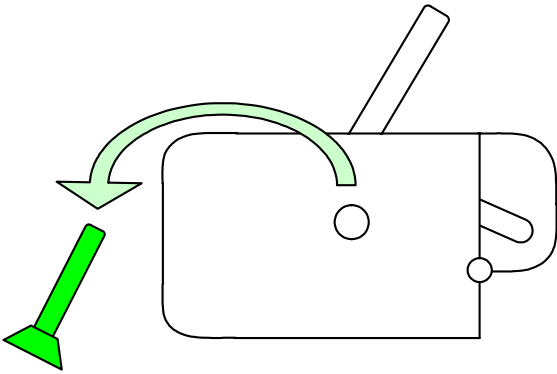

 Warning	<ul style="list-style-type: none"> • Pay due precautions and conduct the on-load release operation in accordance with orders of the officer in charge. • Operation of the release handle upon insufficient confirmation of safety may result in death or injury due to dropping the lifeboat in the water from a height.
---	--

 Caution	<p>Confirm the following before the operation.</p> <ul style="list-style-type: none"> • The lifeboat is as close as possible to the water surface. • The engine is started. • All crew are in their seats with their seatbelts fastened.
---	--

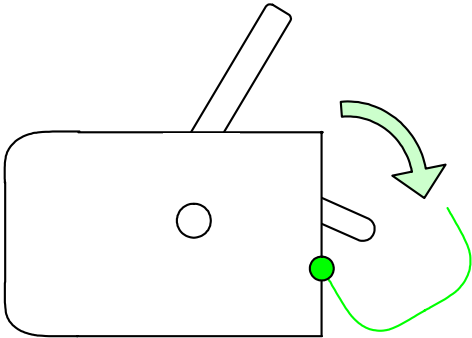
No.	Operation Guide	Schematic Diagram
1	<p>Confirm that the lifeboat is as close as possible to the water surface, but that the hydrostatic interlock is not triggered.</p> <p><Activity in the lifeboat></p>	
2	<p>Pull out the release handle safety pin.</p> <p><Activity in the lifeboat></p>	

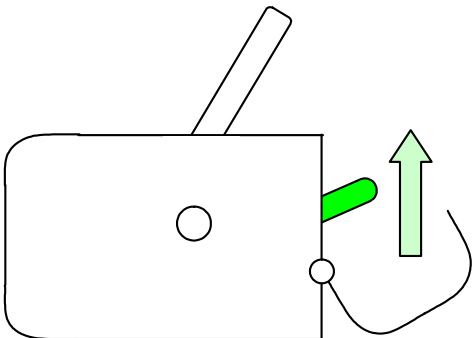
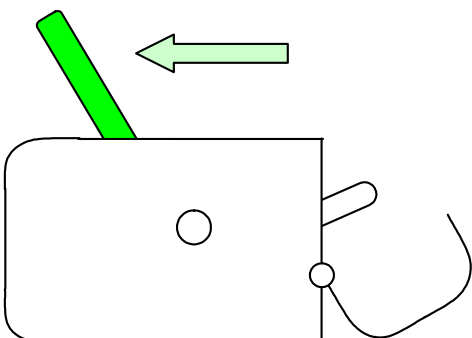
No.	Operation Guide	Schematic Diagram		
3	<p>Open the hydrostatic interlock cover.</p> <table border="1" data-bbox="284 434 746 510"> <tr> <td data-bbox="284 434 405 510">  </td> <td data-bbox="405 434 746 510"> <p>Unlock the latch of the interlock cover.</p> </td> </tr> </table> <p><Activity in the lifeboat></p>		<p>Unlock the latch of the interlock cover.</p>	
	<p>Unlock the latch of the interlock cover.</p>			
4	<p>Lift the hydrostatic interlock lever fully and hold it.</p> <p><Activity in the lifeboat></p>			
5	<p>Pull the release handle to the fully open position by one action.</p> <p><Activity in the lifeboat></p>			

3.8 Painter release and lifeboat operation

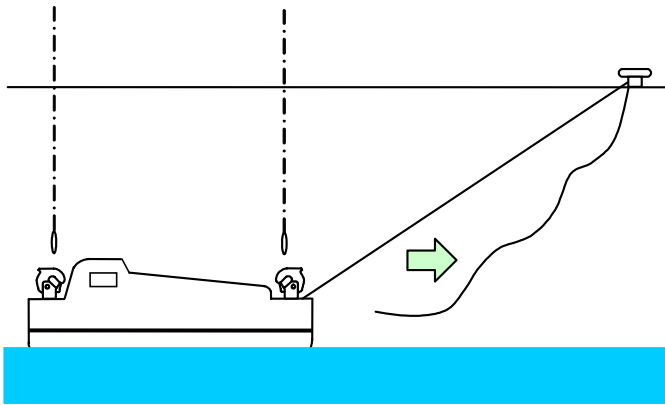
No.	Operation Guide	Schematic Diagram
1	Release the painter. <Activity in the lifeboat>	
2	Lifeboat operation Ahead, astern, turning, spray, lighting of interior light and canopy light, and other performances. <Activity in the lifeboat>	

 Caution	<ul style="list-style-type: none"> • Do not operate the steering gear to turn the lifeboat while the painter is connected. • The lifeboat should get clear of the ship promptly when the painter has been released.
---	---

4 Recovery operation

Outline of the resetting procedures is shown in the following figure.



- **Incomplete resetting may result in death or serious injury due to dropping of the lifeboat in the water from a height.**

Warning

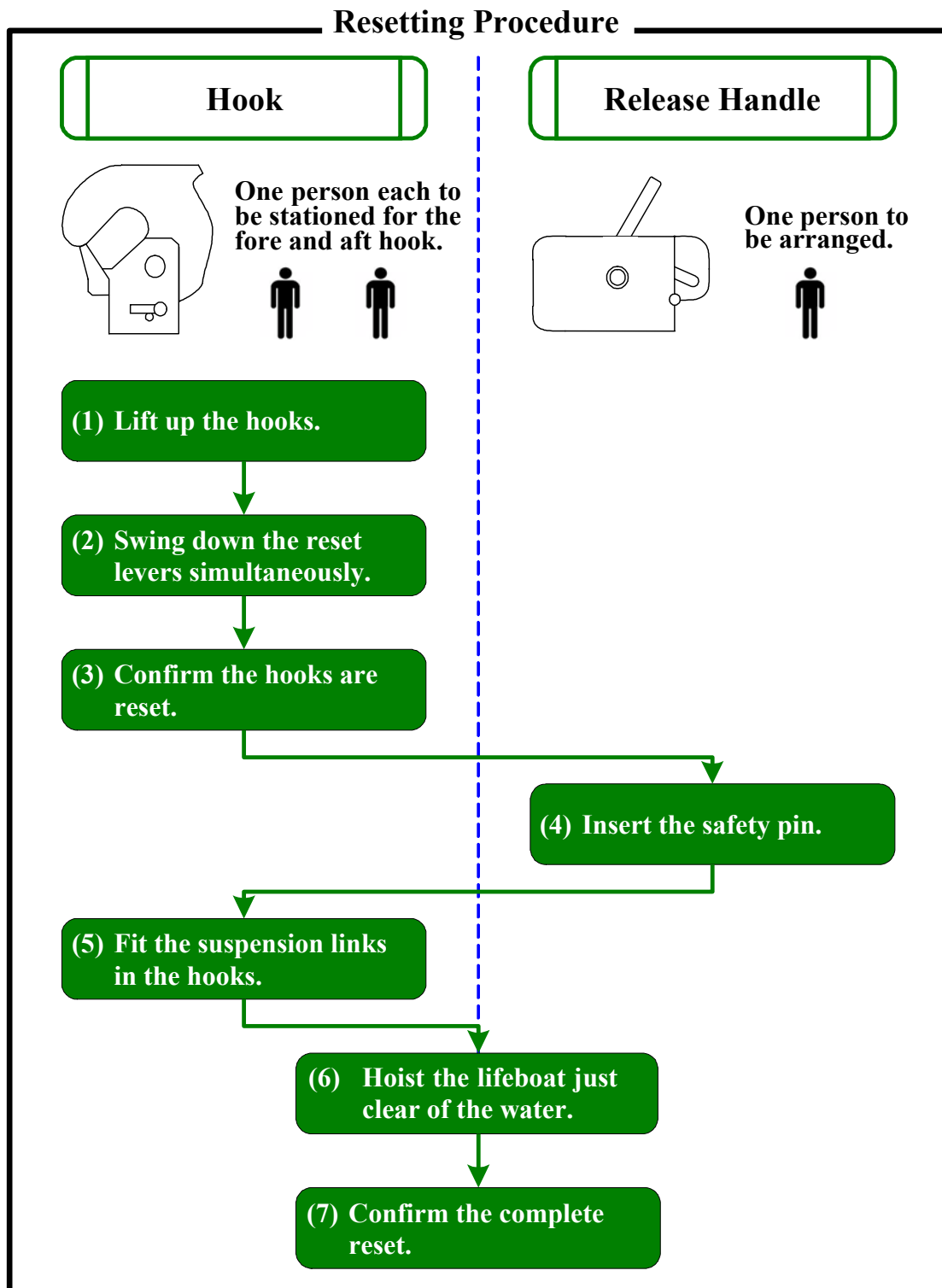





4.1 Resetting procedure of release hook



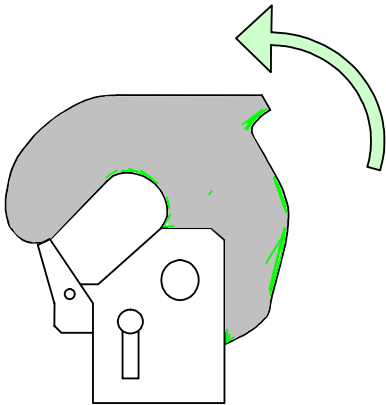

The resetting procedure is to be in accordance with the following steps.

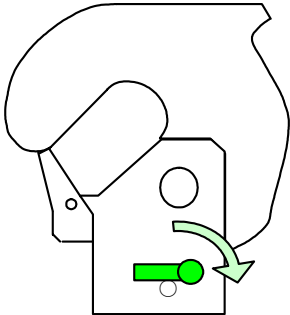

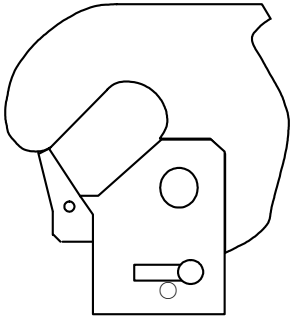
At least three people are required for the resetting of the hooks.

Note

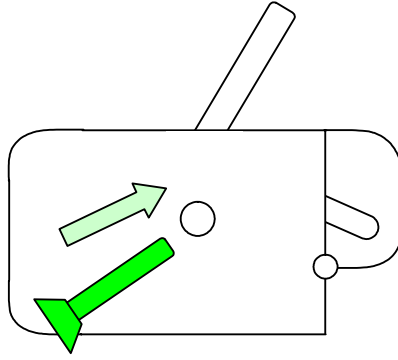
No.	Operation Guide	Schematic Diagram
1	<p>Lift the fore and aft hooks and hold them closed.</p> <div style="border: 1px solid black; padding: 5px; margin-top: 10px;">  <p>A strong effort may be required to lift the hook and force the internal lock piece to engage.</p> </div> <p><Activity in the lifeboat></p>	
2	<p>Simultaneously swing down the reset levers on both fore and aft hooks in one continuous action to contact with the stop.</p> <div style="border: 1px solid black; padding: 5px; margin-top: 10px;">  <p>The release handle returns to its closed (locked) position automatically when the reset levers are swung down.</p> </div> <p><Activity in the lifeboat></p>	
3	<p>Confirm the fore and aft hooks are in the normal reset positions.</p> <div style="border: 1px solid black; padding: 5px; margin-top: 10px;">  <p>Make sure that the reset lever is in contact with the stop.</p> </div> <p><Activity in the lifeboat></p>	

No.	Operation Guide	Schematic Diagram		
4	<p>Make sure that the release handle is in the closed (locked) position and insert the safety pin.</p> <table border="1" data-bbox="284 443 746 589"> <tr> <td data-bbox="284 443 403 589">  </td> <td data-bbox="403 443 746 589"> <p>If the release handle is not in its closed (locked) position, it is not possible to insert the safety pin.</p> </td> </tr> </table> <p><Activity in the lifeboat></p>		<p>If the release handle is not in its closed (locked) position, it is not possible to insert the safety pin.</p>	
	<p>If the release handle is not in its closed (locked) position, it is not possible to insert the safety pin.</p>			





4.2 Recovery procedure

The recovery procedure is to be in accordance with the following steps only after completing the release gear resetting.

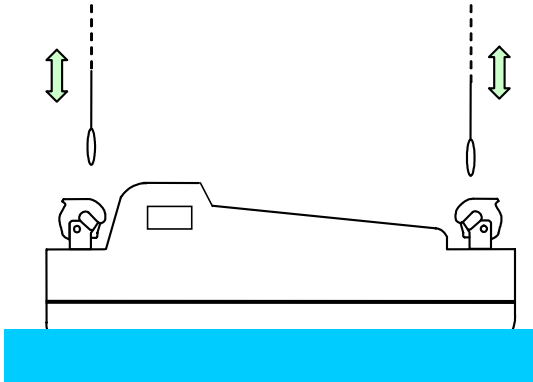
 <p>Warning</p>	<ul style="list-style-type: none"> • Great care must be exercised in reconnecting the hooks that hands and fingers are kept clear. • Failure to confirm proper resetting or to follow all steps below may result in death or serious injury due to dropping the lifeboat in water from a height.
--	--

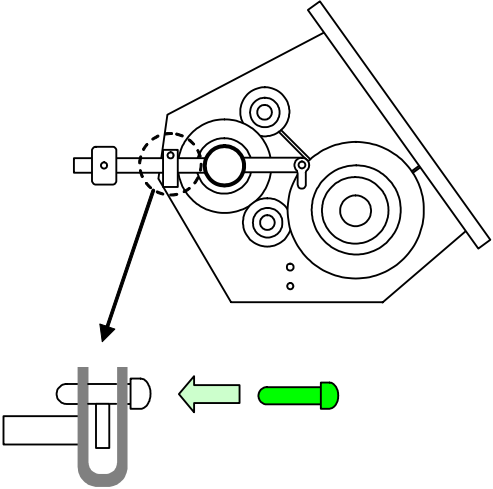
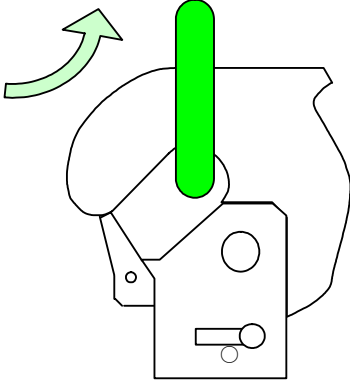
4.2.1 Connection of the suspension link

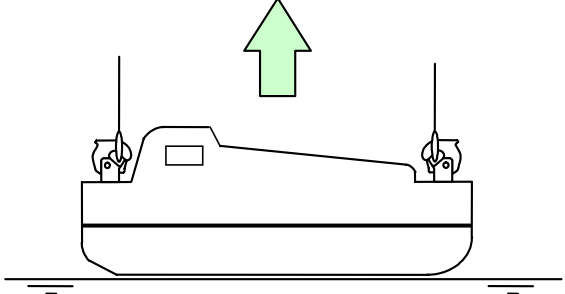
No.	Operation Guide	Schematic Diagram
1	<p>Manoeuvre the lifeboat to come under boat falls.</p>	
2	<p>Adjust the heights of the suspension links by raising or lowering the boat falls.</p> <p><Activity on the ship> and <Activity in the lifeboat> under good communication.</p>	

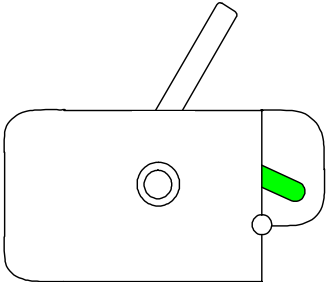
No.	Operation Guide	Schematic Diagram		
3	<p>Insert the safety pin of the boat winch handbrake.</p> <p><Activity on the ship></p>			
4	<p>Connect the suspension links of the davit simultaneously to both, fore and aft hooks.</p> <p><Activity in the lifeboat></p>			
5	<p>Hoist the lifeboat just clear of the water and stop hoisting.</p> <table border="1" data-bbox="284 1424 746 1529"> <tr> <td data-bbox="284 1424 403 1529">  </td> <td data-bbox="403 1424 746 1529"> <p><u>Confirm that the fore and aft hooks are properly connected.</u></p> </td> </tr> </table> <p><Activity on the ship> and <Activity in the lifeboat></p>		<p><u>Confirm that the fore and aft hooks are properly connected.</u></p>	
	<p><u>Confirm that the fore and aft hooks are properly connected.</u></p>			
6	<p>Confirm that the hydrostatic interlock lever has moved to the “locked” position for the lifeboat not being waterborne.</p> <p><Activity in the lifeboat></p>			
7	<p>Where the resetting is incomplete, return to the first step.</p>			

Do not conduct recovery operation of the lifeboat unless the above procedures are fully completed.

 Caution	<ul style="list-style-type: none"> ✓ Do not connect the suspension link of the davit to the hooks until reset of the hooks has been fully completed. It is dangerous to connect the suspension link during the resetting operation of the hook and results an incomplete reset. ✓ In case of using recovery strops, it is required to connect the bottom link of the strops instead of the suspension link to the hooks.
---	--

 Warning	<ul style="list-style-type: none"> ✓ Both hooks should be connected simultaneously to prevent damage due to excessive load on one hook. ✓ If only one hook is connected, the lifeboat may be suspended by the single hook due to wave action resulting in injury or death.
---	--

4.2.2 Hoisting the lifeboat

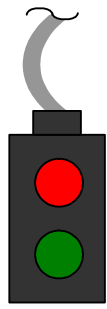
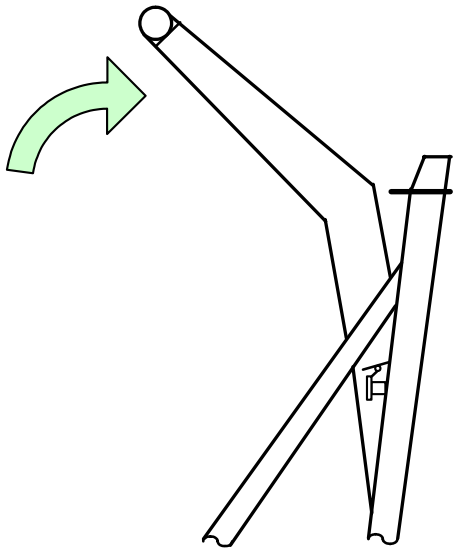
No.	Operation Guide	Schematic Diagram
1	<p>Hoist the lifeboat by operating the winch using the push-button switch following the instruction by the officer in charge.</p> <p><Activity on the ship></p>	
2	<p>Hoist the lifeboat until the winch is stopped by the limit switch.</p> <p><Activity on the ship></p>	

 Caution	<ul style="list-style-type: none"> • The boat winch stops automatically when the davit arm strikes the limit switch. • Where the limit switch of boat winch does not work correctly, the winch operator should manually stop the hoisting operation immediately.
---	--

No.	Operation Guide	Schematic Diagram
3	Disembark from the lifeboat. <Activity on the ship> and <Activity in the lifeboat>	

4.3 Stowage procedure

 Note	Position two persons on davit platform to watch for proper stowage.
--	--

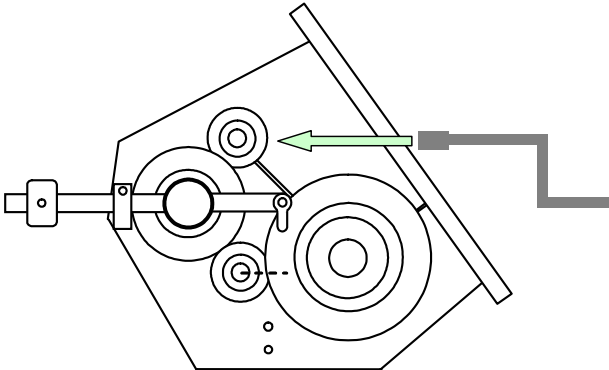
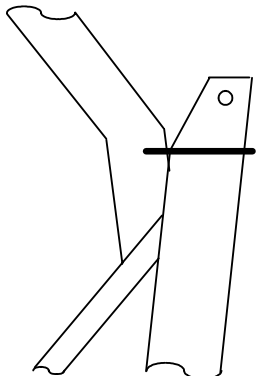
No.	Operation Guide	Schematic Diagram
1	Hoist the davit arm manually. <Activity on the ship>	
2	Confirm that the davit arm is in contact with the stop on platform. <Activity on the ship>	



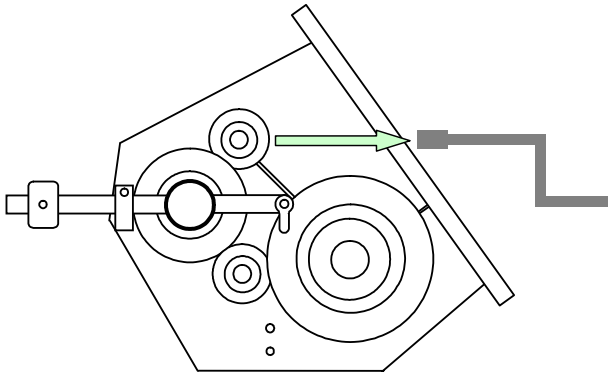
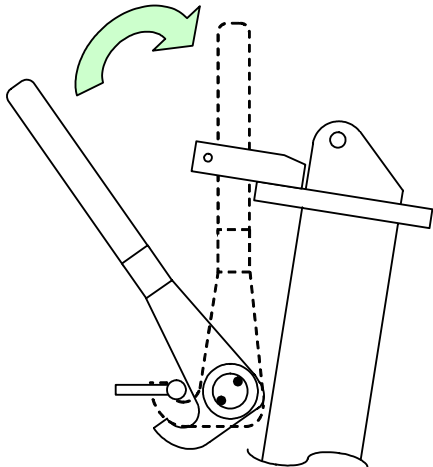
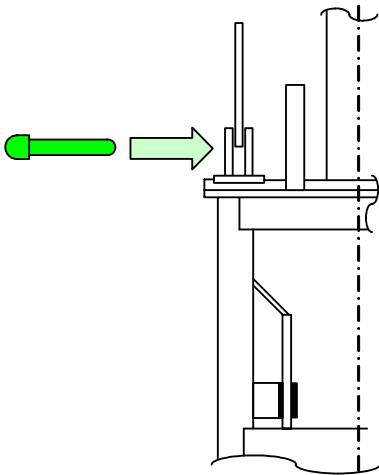

 Caution	<ul style="list-style-type: none"> • Each person on the platform should signal to the winch operator just when the davit arm reaches the stop on the frame. • Confirm that the davit arm and the stops are in contact fore and aft.
---	---

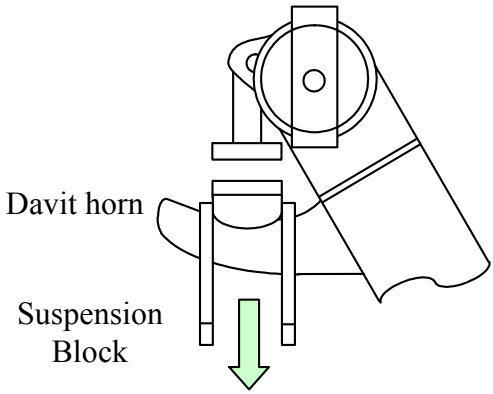
 Warning	<ul style="list-style-type: none"> • Stop the hoisting operation immediately when the signal from the watchman is received. • Over hoisting by manual operation may have serious consequences due to damage of the boat fall and the davit.
---	---

No.	Operation Guide	Schematic Diagram
3	<p>Detach the manual hoisting handle.</p> <p><Activity on the ship></p>	
4	<p>Set the davit arm stop immediately.</p> <p><Activity on the ship></p>	
5	<p>Insert the safety pin to the davit arm stop handle.</p> <p><Activity on the ship></p> <p>Note: Safety pins are generally intended only for use during maintenance or in port.</p>	

No.	Operation Guide	Schematic Diagram
6	<p>Lower the suspension block on the davit horn by releasing the handbrake of the winch.</p> <p><Activity on the ship></p>	 <p>Davit horn</p> <p>Suspension Block</p>

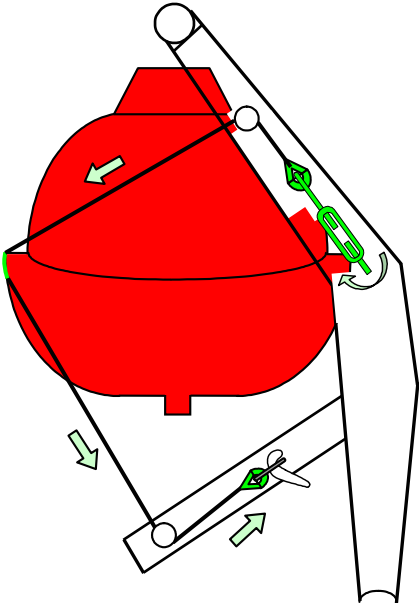
 Warning	<ul style="list-style-type: none"> If the suspension blocks are not on the davit horn, the boat falls remain in tension during sea going and the load may cause damage to the boat falls.
---	---

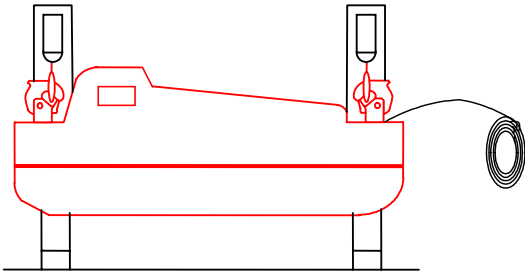
No.	Operation Guide	Schematic Diagram		
7	<p>Install and tighten the auto release gripe, if fitted.</p> <table border="1" data-bbox="280 1361 753 1438"> <tr> <td style="text-align: center;"></td> <td>Tighten the auto release gripe rope with the tumbuckle.</td> </tr> </table> <p><Activity on the ship></p>		Tighten the auto release gripe rope with the tumbuckle.	
	Tighten the auto release gripe rope with the tumbuckle.			
8	<p>Connect the painter to the painter release hook on the bow of lifeboat.</p> <p><Activity on the ship></p>			

5 On-load/off-load release gear system

5.1 General

This section describes the details of the release gear system. Read this section carefully for safe operation. This release gear system consists of fore and aft hooks, a release handle near the steering console, a hydrostatic unit and the associated cables (see Fig. 5.1).

The releasing operation of the hooks is conducted at the release handle near the steering console through the control cables terminating at the fore and aft hooks. The interlock system including the hydrostatic interlock unit is provided to prevent the release of the hooks when the boat is not waterborne.

The system also has an on-load release function which makes it possible to over-ride the interlock by the hydrostatic unit. Incorrect on-load release operation may cause fatalities and due precautions should be taken for this operation.

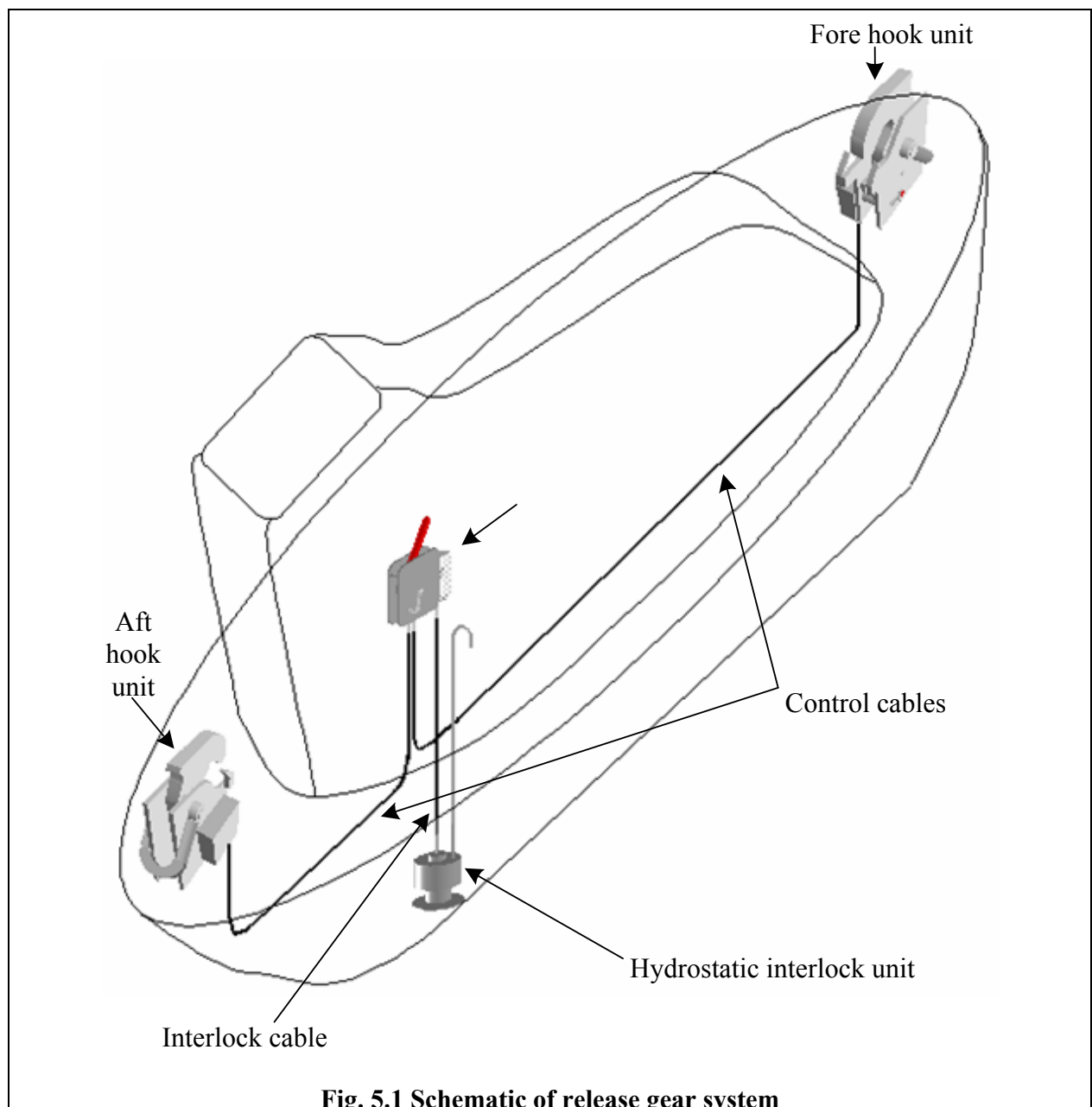

5.2 Fore and aft hook units

5.2.1 Structure and parts names

The structure and parts names of the fore and aft hooks are shown in Figures 5.2.1.1 and 5.2.1.2. The fore and aft hooks are generally identical except for the direction of installation.

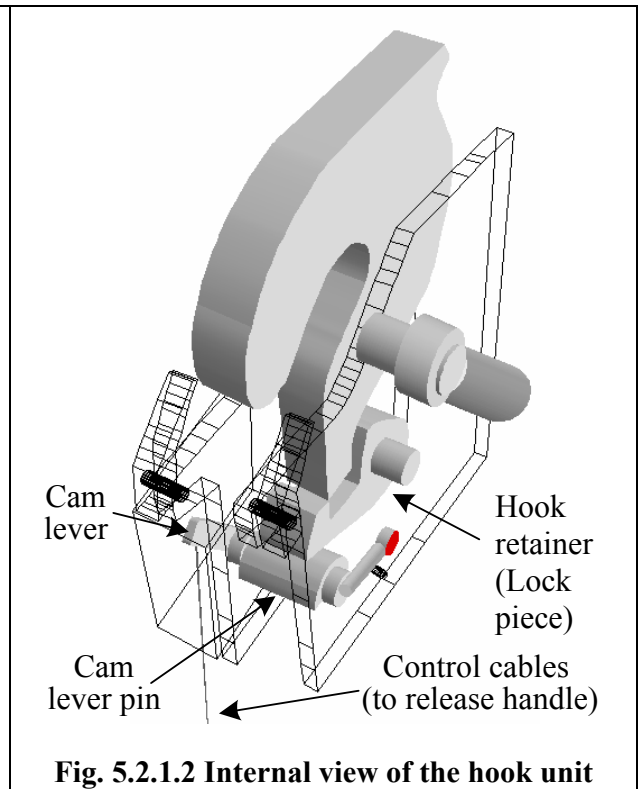
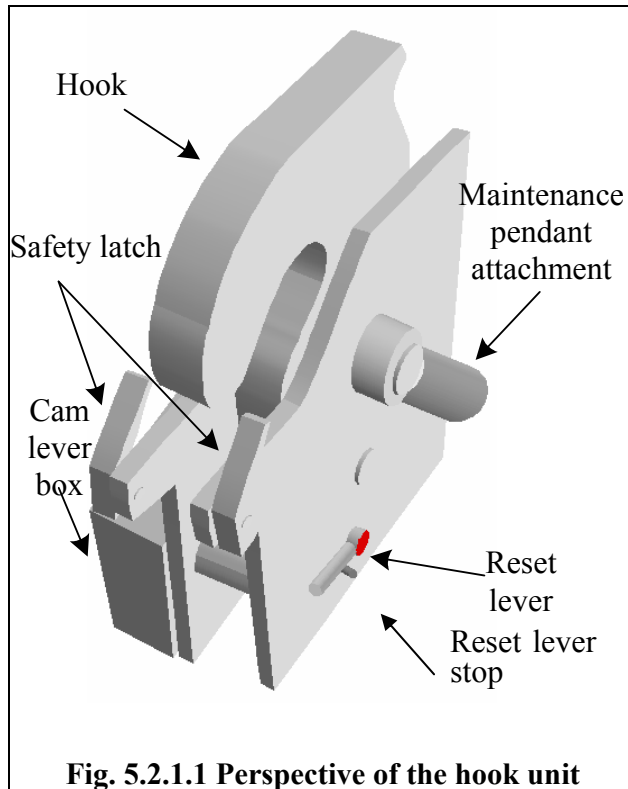

5.2.2 Releasing

When the release handle near the steering console is pulled, the cam lever pin is turned by the control cable and the lock piece is then made free. Finally the hook is turned and released (see figure 5.2.2).

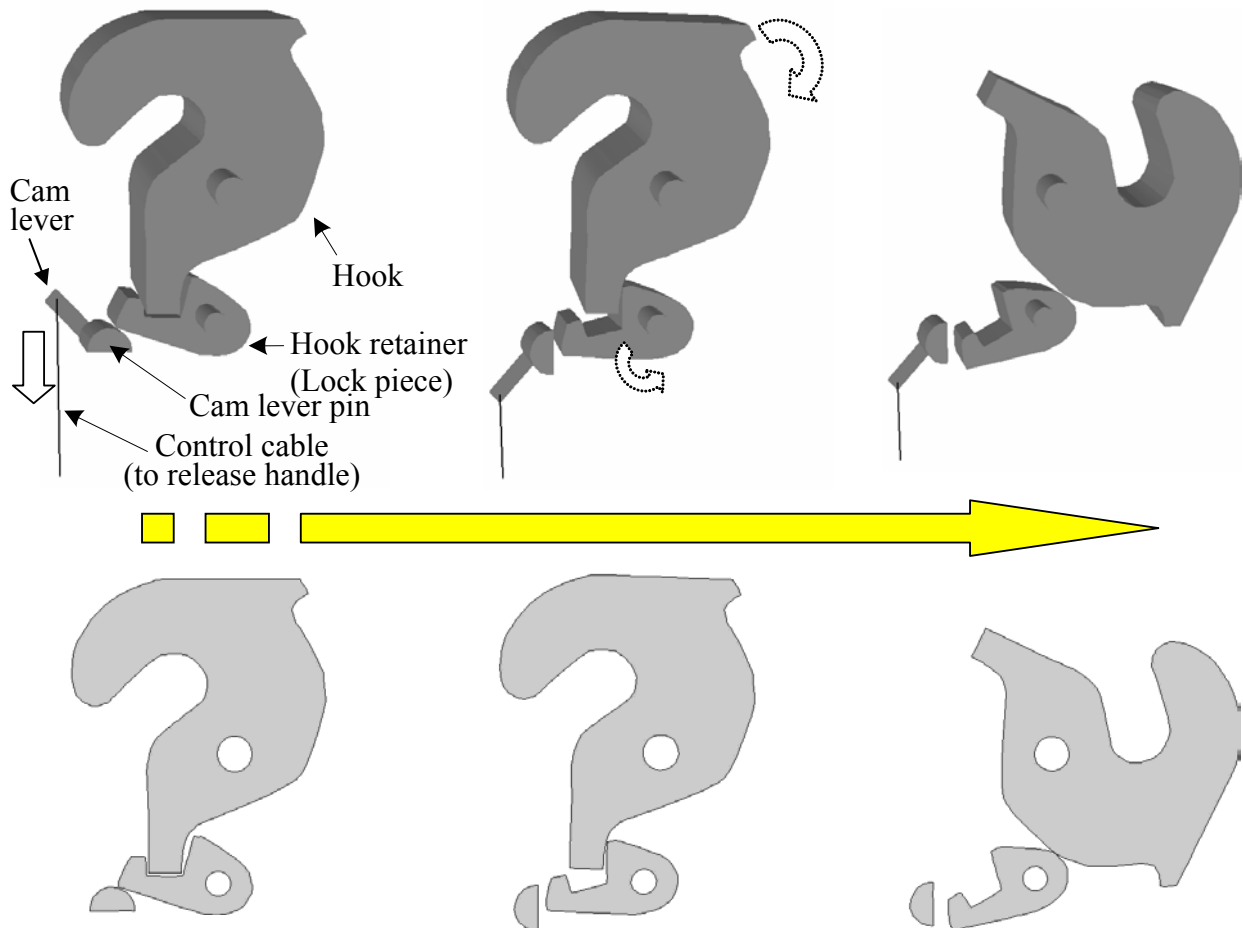

Fig. 5.2.2 Release principle of the hook unit

5.2.3 Resetting

After the resetting of hooks, the posture of each hook is held by the lock piece and the lock piece is locked by the cam lever pin with the reset lever. To ensure the proper resetting of the fore and aft hooks, the procedures described in paragraph 4.1 should be followed. The fore and aft reset levers must be operated simultaneously. After simultaneous resetting of the hooks, the release handle near the steering console also returns to the closed position (see figure 5.2.3).

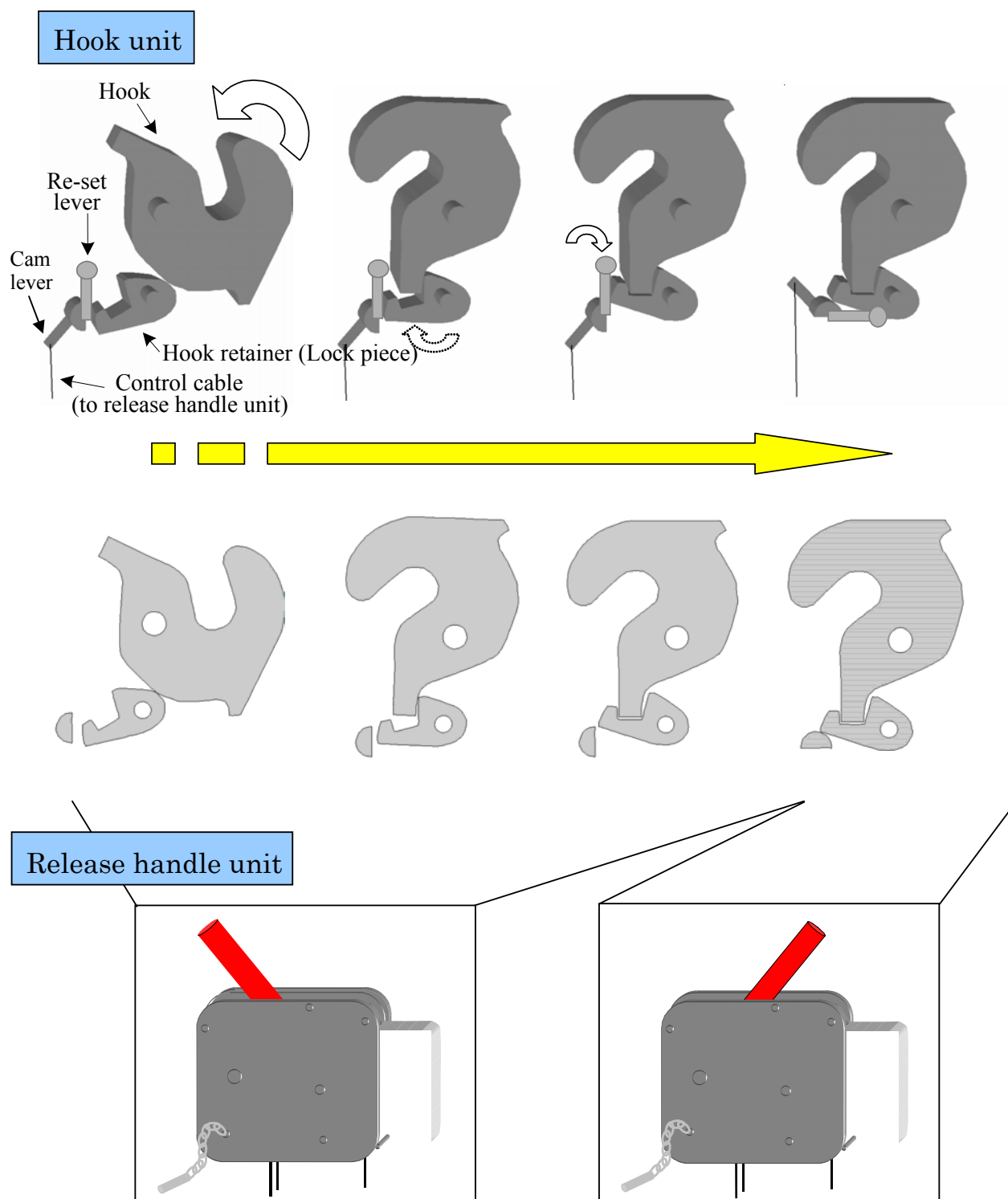
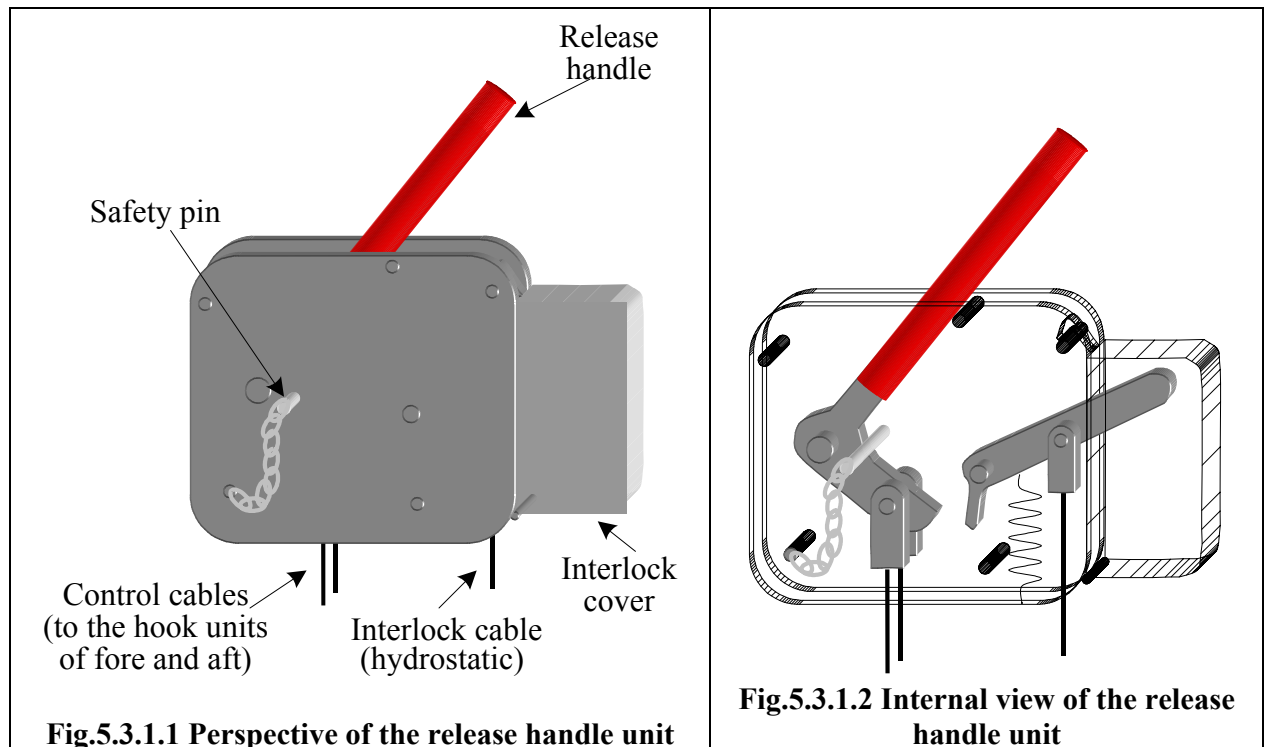

Fig. 5.2.3 Reset principle of the hook unit

5.3 Release handle unit

5.3.1 Structure and parts names

The structure and parts names of the release handle are shown in figures 5.3.1.1 and 5.3.1.2.



5.3.2 Operation

When the lifeboat is fully waterborne, the lifeboat can be released by removing the safety pin and then pulling the release handle fully and quickly to the open position (off-load release). The lifeboat can also be released by the same operation of the release handle even though the lifeboat is not fully waterborne, by opening the interlock cover and lifting up the interlock lever. This over-rides the interlock function of the hydrostatic interlock unit (on-load release).

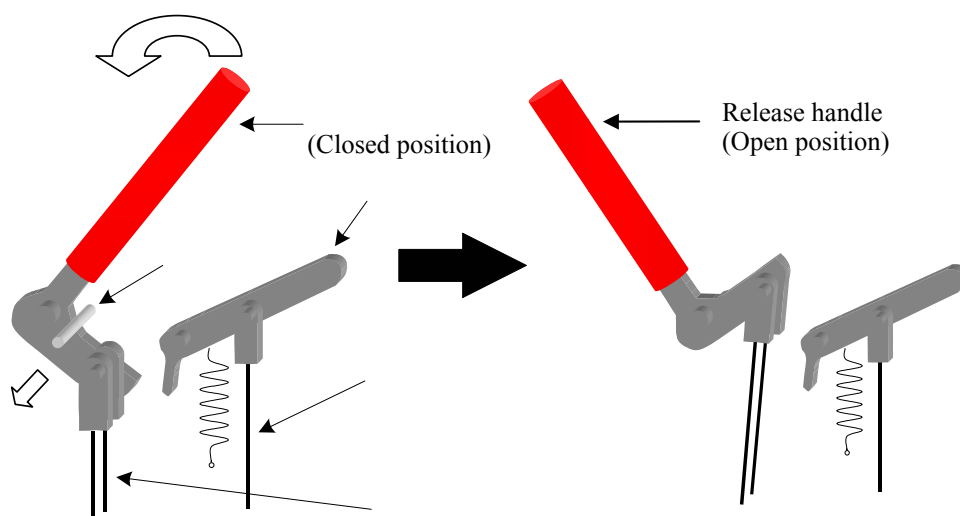
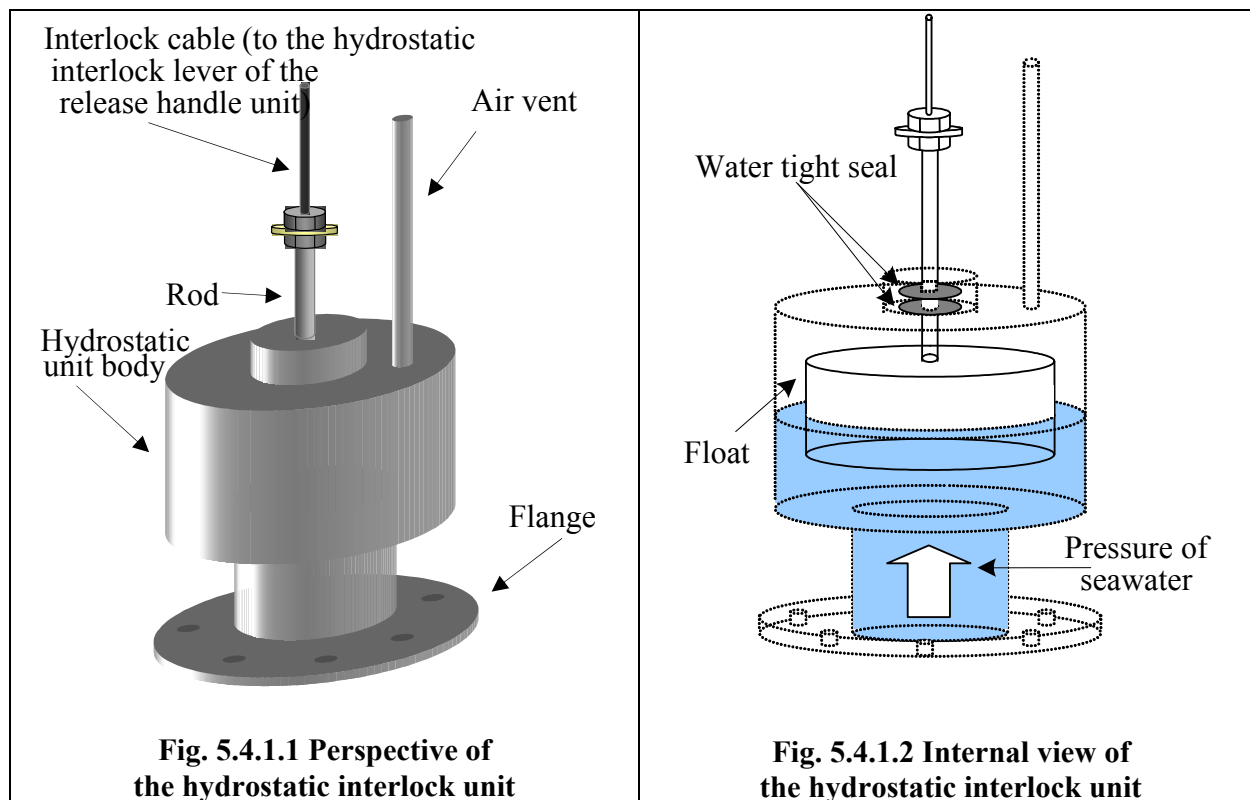

Fig. 5.3.2 Operation procedure of the release handle

5.4 Hydrostatic interlock unit

5.4.1 Structure and parts name

Structure and parts names of the hydrostatic interlock unit are shown in figures 5.4.1.1 and 5.4.1.2.



5.4.2 Operation

When the lifeboat is fully waterborne, the hydrostatic interlock unit pushes up the interlock lever through the interlock cable by the water lifting the float and thus allowing the release handle to be operated. Contrary to this, operation of the release handle is not allowed by the hydrostatic interlock unit when the lifeboat is not fully waterborne.

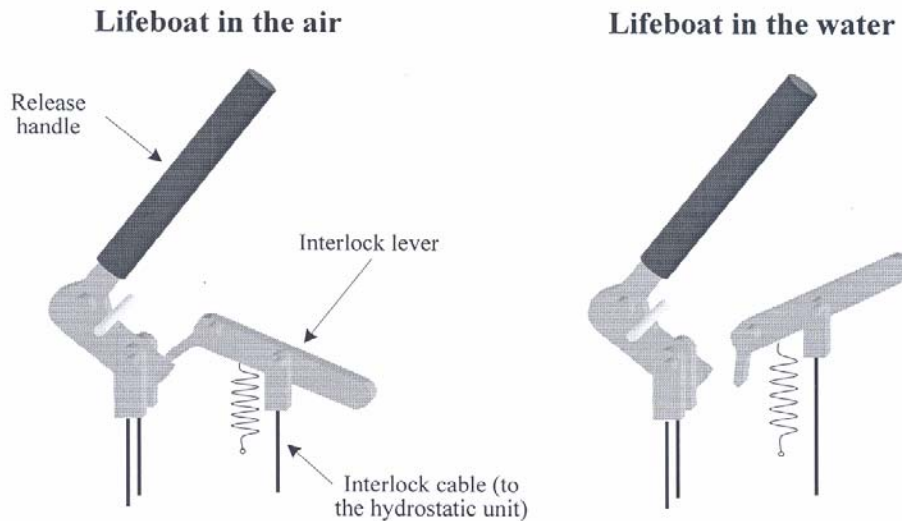

Fig. 5.4.2 Schematic diagram of the interlock

6 Inspection and maintenance

6.1 General precautions

SOLAS regulation III/20 requires that all life-saving appliances shall be in working order and ready for immediate use before the ship leaves port and at all times during the voyage. Lifeboats, launching appliances and release gear are required by SOLAS regulation III/20 to be inspected weekly and monthly according to the instructions for on-board maintenance complying with the requirements of SOLAS regulation III/36. Also, MSC.1/Circ.1206 describes more detailed procedures for periodic servicing and maintenance of lifeboats, launching appliances and release gear.

This manual includes only the weekly and monthly inspection and maintenance, which are conducted on board under the direct supervision of a senior ship's officer.

6.2 Inspection and maintenance of lifeboat and release gear system

6.2.1 Inspection and maintenance plan

Lifeboats should be inspected and maintained weekly and monthly in accordance with the following tables. The tables list the items to be checked, the method of inspection, the procedures to be followed, and the frequency at which the items are to be attended to.

Table 6.2.1.1 covers the basic lifeboat (including release gear).

Table 6.2.1.2 covers the lifeboat engine.

Table 6.2.1.3 covers the electric parts.

Table 6.2.1.4 covers the lifeboat equipment.

Table 6.2.1.1 - Inspection procedure and maintenance plan for boat

Items		Method	Inspection procedure	Maintenance plan	
				Weekly	Monthly
Outside hull		Visual	Inspect for deformation or other defects. Inspect for peeling or any damage of retro-reflective material.	X	X
Outside canopy		Visual	Inspect for deformation or other defects.	X	X
Buoyant lifeline		Visual	Inspect for any damage.	X	X
Foldable canopy ^{*1}		Visual	Inspect for any damage to canopy.	X	X
Inside boat	GRP	Visual	Inspect for deformation or other defects.	X	X
	Wood	Visual	Inspect for crack or rot.	X	X
	Metal	Visual	Inspect for corrosion.	X	X
Drain valve		Visual	Inspect for any damage.	X	X
Release gear		Visual	Check resetting condition. Remove any dirt on moving parts.	X	X
Painter release device		Visual	Check resetting condition. Remove any dirt on moving parts.	X	X
All hatches		Visual Operation	Inspect for easy operation and good condition of gasket.	X	X
Window		Visual	Inspect for any crack on glass. Clean both sides of glass.		X
Steering gear		Visual	Inspect for any damage of rudder, tiller and emergency tiller.	X	X
		Operation	Inspect for good operation of main steering and connecting emergency tiller.	X	X
Stern tube		Visual	Inspect gasket and check for leakage of seawater.	*2	*2
Propeller and guard		Visual	Inspect for any damage.	X	X
Breather valve		Operation	Inspect operation of valve.		X
Water spray system	Clutch V-belt	Visual	Inspect for proper tension of V-belt. Inspect for any damage of belt.		X
		Operation	Inspect for proper operation.		X
	Spray pipe	Visual	Inspect for corrosion or any damage.		X
	Spray nozzle	Visual	Remove any deposit.		X
Air support system	High pressure pipe	Visual	Inspect for any damage.		X
	Regulator	Visual	Inspect for any damage.		X
	Air cylinder	Visual	Inspect for corrosion or any damage.		X

Note: 1 Applicable only to partially enclosed lifeboats.
2 When waterborne.

Table 6.2.1.2 - Inspection procedure and maintenance plan for engine

Items	Method	Inspection procedure	Maintenance plan	
			Weekly	Monthly
Engine	Visual	Check in good condition.		X
	Operation	Start and operate the engine. Check operation of throttle. Check operation of clutch.	X	X
Lubricating oil	Visual	Check an amount of oil.		X
	Visual	Check viscosity of oil with finger and ensure it's not dirty.		X
Fuel oil tank	Visual	Check securing condition of the tank (corrosion or leakage and connecting parts). Check an amount of fuel oil.		X
Fuel oil pipe	Visual	Check any leakage on connecting parts.		X
Water cooler	Visual	Check an amount of fresh water.		X
Cooling water pipe	Visual	Check any leakage on pipe.		X
Starter switch	Operation	Check operating properly.	X	X
Glow lamp	Operation	Check light on when pre-heating.	X	X
Tachometer	Operation	Check proper indication of revolution.	X	X
Oil pressure warning lamp, Charge lamp	Operation	Check proper light on or light off condition.	X	X
Stop wire	Operation	Stop the engine.	X	X

Table 6.2.1.3 - Inspection procedure and maintenance plan for electric parts

Items	Method	Inspection procedure	Maintenance plan	
			Weekly	Monthly
Battery	Visual	Check lead wire.		X
	Measure	Measure voltage of battery. When voltage is low, charge battery.		X
Inside lamp	Operation	Check light on.		X
Canopy lamp	Operation	Check light on.		X
Search light	Operation	Check light on.		X
Electric wiring	Visual	Check any defects on wiring.		X

Table 6.2.1.4 - Inspection procedure and maintenance plan for lifeboat equipment

Check for condition, quantity and expiry date where applicable

No.	Items	Maintenance plan	
		Weekly	Monthly
1	Oars		X
2	Thole pins or crutches		X
3	Boat hooks		X
4	Buoyant bailer		X
5	Buckets		X
6	Survival manual	X	X
7	Compass		X
8	Sea-anchor		X
9	Painters		X
10	Hatchets		X
11	Watertight receptacle and fresh water		X
12	Dipper with lanyard		X
13	Graduated drinking vessel		X
14	Food ration in watertight container		X
15	Rocket parachute flare		X
16	Hand flare		X
17	Buoyant smoke signal		X
18	Waterproof electric torch		X
19	One daylight signalling mirror		X
20	One copy of life-saving signals	X	X
21	One whistle		X
22	A first-aid kit		X
23	Anti-seasickness medicine		X
24	One seasickness bag for each person		X
25	A jack knife		X
26	Three tin openers		X
27	Two buoyant rescue quoits		X
28	A manual pump	X	X
29	One set of fishing tackle		X
30	Portable fire-extinguishing equipment		X
31	A radar reflector		X
32	Thermal protective aids		X
33	Compartments for storage		X
34	A means for collecting rainwater		X
35	A boarding ladder		X
36	Seat belts		X
37	Instructions of immediate action	X	X
38	Water resistant instructions	X	X

6.2.2 *On board maintenance procedures*

6.2.2.1 *General*

As a result of inspection, any defective parts should be repaired in accordance with following procedures. Any shortage of quantity should be supplemented to the correct number. Defective parts other than the following should be recorded along with their details and ordered for maintenance and repair by the manufacturers.

6.2.2.2 *Boat*

6.2.2.2.1 *Rust on metal parts*

Give anti-rusting treatment according to degree of damage, or replace if significantly wasted.

6.2.2.2.2 *Damage of fabric*

Repair fabric products by same material according to degree of damage.

6.2.2.2.3 *Gasket*

Repair with adhesive sealant according to degree of damage.

6.2.2.2.4 *Drain valve*

Remove any dirt and check correct operation.

6.2.2.2.5 *Water spray system*

Remove any deposit from spray nozzles. Tighten up pipe connecting parts when any leakage was noted. Adjust to proper tension on V-belt.

6.2.2.3 *Engine*

6.2.2.3.1 *Oil coating and filling*

When any rust exists, remove rust and coat with machine oil. Rotating parts should be filled with lubricating oil.

6.2.2.3.2 *Operating test*

An operational test of the engine should be carried out on board the ship and in the afloat condition after launching at an appropriate opportunity to check the running condition. After the operational test, ensure that the valves for the cooling water line are opened and flushed with fresh water and drained completely.

6.2.2.4 Electric parts

6.2.2.4.1 Battery

Fill up battery with electrolyte if level is below the designated position. Tighten up electric terminal if it is loose.

6.3 Inspection and maintenance of launching appliances (davits and winches)

6.3.1 Inspection and maintenance plan

Launching appliances should be inspected and maintained weekly and monthly in accordance with the following tables. The tables list the items to checked, the method of inspection, the procedure to be followed, and the frequency at which the items are to be attended to.

Table 6.3.1.1 covers the davit.

Table 6.3.1.2 covers the winch.

Table 6.3.1.3 covers the electric parts.

Table 6.3.1.1 - Inspection procedure and maintenance plan for davit

Items	Method	Inspection procedure	Maintenance plan	
			Weekly	Monthly
Frame	Visual	Check corrosion, deformation and depression.	X	X
Davit arms	Visual	Check corrosion, deformation and depression.	X	X
	Operation	Moving out from stowed position.	X	
	Operation	Turning out from stowed position.		X
Sheave, suspension block	Visual	Check wear and corrosion.		X
	Operation	Check moving condition.	X	X
	Lubricate	Lubricate/grease.		X
Hinge pin, sheave pin	Lubricate	Lubricate/grease.		X
Davit arm stopper and trigger hook	Visual	Check wear and corrosion.	X	X
	Operation	Check moving condition.	X	X
	Lubricate	Lubricate/grease.		X
Boat fall, Turn buckle	Visual	Check wear, breakage of wire and corrosion.		X
	Lubricate	Lubricate/grease.		X
	Turn ends	Turn ends of boat fall (2.5 years).		
	Replacing	Replacing boat fall (5 years).		
Lashing wire rope	Visual	Check wear, corrosion and looseness.	X	X
Deck operation device	Operation	Check moving condition.		X
	Lubricate	Lubricate/grease.		X
Remote control wire	Visual	Check wear and corrosion.	X	X
	Operation	Check moving condition.		X
	Lubricate	Lubricate/grease.		X
Boat chock	Visual	Check wear and corrosion.	X	X

Table 6.3.1.2 - Inspection procedure and maintenance plan for winch

Items	Method	Inspection procedure	Maintenance plan	
			Weekly	Monthly
Gear box, gear, bearing, oil seal	Visual	Check level and deterioration of lubricating oil.		X
	Operation	Check unusual noise.		X
Brake system, Centrifugal brake	Visual	Check corrosion or any defects.	X	X
Wire end cotter	Visual	Check looseness.		X
Brake lever	Visual	Check corrosion or any defects.	X	X
	Operation	Check operating condition.	X	X
Speed change lever	Lubricate	Lubricate/grease.	X	X

Table 6.3.1.3 - Inspection procedure and maintenance plan for electric parts

Items	Method	Inspection procedure	Maintenance plan	
			Weekly	Monthly
Electric motor	Visual	Check wiring.	X	X
	Operation	Check normal operation.		X
Limit switch	Visual	Check wiring.	X	X
	Operation	Check normal operation.		X
	Lubricate	Lubricate/grease.		X
Push-button switch box and cable	Visual	Check wiring and other defects.	X	X
	Operation	Check normal operation.		X
Start panel	Visual	Check wiring and other defects.	X	X
	Operation	Check normal operation.		X

6.3.2 On-board maintenance procedure

6.3.2.1 General

As a result of inspection, any defective parts should be repaired in accordance with following procedures. Any shortage of quantity should be supplemented to correct number. Defective parts other than the followings should be recorded along with their details and ordered for maintenance and repair by the manufacturers.

6.3.2.2 Wire rope

6.3.2.2.1 Wire ropes should be changed in the following cases:

- .1 break of elemental wire was observed;
- .2 7% reduction of nominal diameter was observed;
- .3 kink or looseness of ply was observed; or
- .4 erosion/corrosion was observed.

6.3.2.2.2 Check fixing condition of wire ropes.

6.3.2.2.3 Change the boat falls within an appropriate period.

6.3.2.2.4 Adjust the length of boat falls as necessary so that the clearances between the davit arm and davit arm stopper at fore and aft are almost the same.

6.3.2.2.5 Ensure that material and diameter of suspension links are as specified by the release gear manufacturer.

6.3.2.3 *Boat winch*

6.3.2.3.1 Prior to commencement of the maintenance work for the winch, the boat should be secured to prevent movement.

6.3.2.3.2 Oil should be checked and changed if discoloured. In case that oil level is low, oil should be added until the its surface comes to the designated level in the oil gauge.

6.3.2.3.3 Surfaces of each gear inside the gear box should be checked. In case that a defect is found on a surface of gear, the gear box should be replaced or repaired.

6.3.2.3.4 In case that the angle of brake lever has dropped due to abrasion of the brake lining, the angle of the brake lever should be adjusted by loosening the bolts, adjusting the angle and tightening the bolts again.

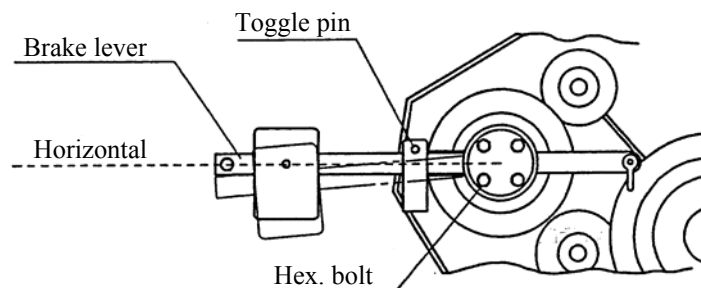

6.3.2.4 *Greasing*

6.3.2.4.1 Lubrication is essential for the function of the davit and winch and regular checking is necessary. Greasing also should be regularly conducted. For appropriate greasing, the detailed structure of the davit and winch and the functions of their parts should be understood.

6.3.2.4.2 All grease nipples of the davit should be greased at least once a month.

6.3.2.4.3 Gear oil inside the boat winch should regularly be checked regarding amount, change of colour and mixture of moisture.

6.3.2.4.4 Wire rope oil/grease should be regularly checked to prevent loss of oil/grease. Wire rope should be oiled or greased every two months in general.